



# MarCal. Caliper

## Overview

### MarCal Caliper

26

#### Standard Calipers

### MarCal 16 EWRI

30

Integrated Wireless Waterproof Caliper with a Digital Display

### MarCal 16 EWR

31

Waterproof Caliper with a Digital Display

### MarCal 16 ER

33

With a Digital Display

### MarCal 16 U

35

With Dial

### MarCal 16 FN / 16 GN / 16 N / 16 DN

36

With a Line Scale (Vernier)

#### Universal Calipers

### MarCal 16 EWRI-V / 16 EWR-V / 18 EWR-V

40

With a Digital Display

#### Special Calipers

43

Waterproof Caliper in special design

#### Workshop Calipers

### MarCal 18 EWR / 18 ESA

57

With a Digital Display

### MarCal 18 NA / 18 N / 18 DN

60

With a Line Scale (Vernier)

#### Digital Depth Gage

### MarCal 30 EWRI

65

Waterproof Caliper with a Digital Display

### MarCal 30 EWR / 30 EWN / 30 EWRI-D / 30 EWR-D / 30 EWRI-N / 30 EWR-N

66

With a Digital Display

### MarCal 30 N / 30 NH / 30 ND

70

With a Line Scale (Vernier)

#### Linear Machine Scales

### MarCal 31 EW

73

With a Digital Display



# MarCal. Calipers

## OVERVIEW

### MarCal - Design Features

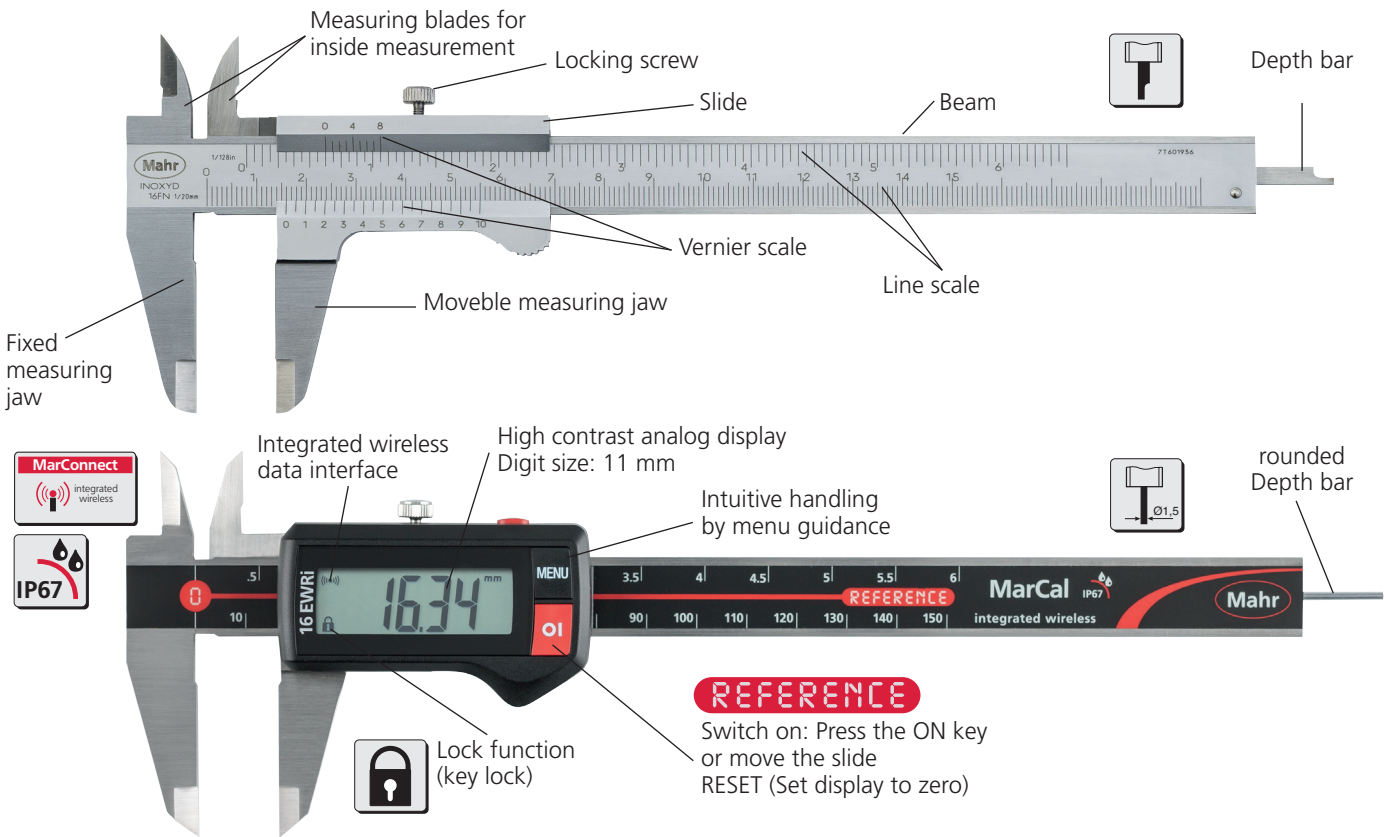

### MarCal - Types on measurement

16 series calipers (e.g. 16 EWri, 16 U, 16 FN) can be used to conduct 4 different types of measurements:

a) Outside measurement

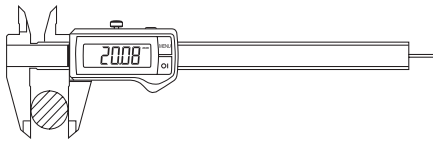

b) Inside measurement

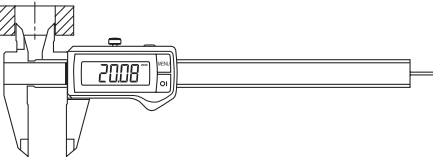

c) Depth measurement

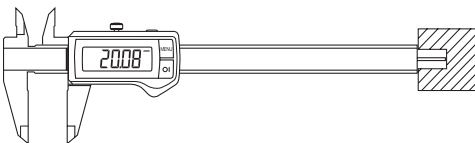

d) Step (Distance) measurement

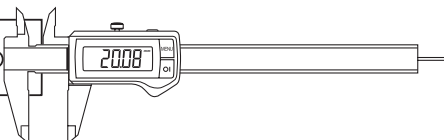

### Error limits G according to DIN 862

Measuring length	Error limits G in $\mu\text{m}$		
	Scale interval and/or vernier interval		Resolution
mm	0,1 and 0,05	0,02	0,01
50	50	20	20
100			
200			
300	60	30	30
400			
500			
600	80	40	40
700			
800			
900	110	50	40
1000			
1200			
1400	160	60	—
1600			
1800			
2000	220		



# MarCal - The innovative Reference-System

## Just set once to zero

All Mahr digital calipers with this **REFERENCE** logo are equipped with the innovative Reference System. The zero position just has to be set once: after setting the zero position, the zero remains stored for all further measurements. Therefore, once the caliper is switched ON or the slide is moved the caliper is immediately ready for measurement. Once the caliper is initially set to zero, there is no need to reset to zero each time the caliper is turned on.

### Conventional

- ① Switch ON
- ② Close the measuring jaws
- ③ Set to zero
- ④ Results of measurement

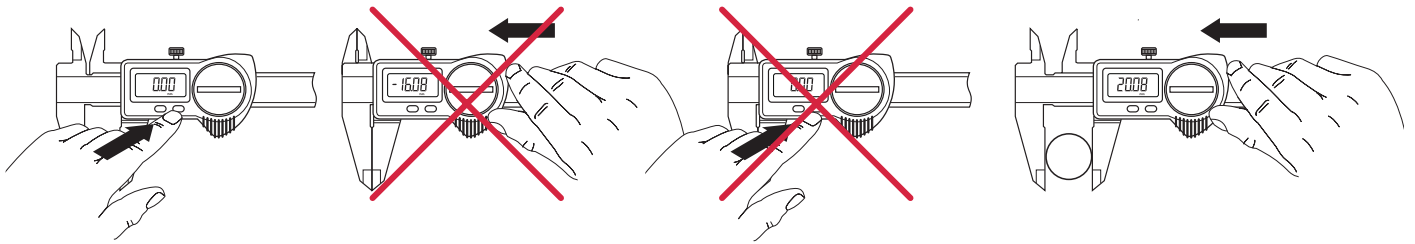

### REFERENCE - System

- ① Switch ON
- ② Results of measurement



Press the ON key or move the slide

## IP-Protection classes

First digit is the degree of protection according to IEC 60529

Protection against particles, contaminants and dust

- 0 Not protected
- 1 Particles > 50,0 mm
- 2 Particles > 12,5 mm
- 3 Particles > 2,5 mm
- 4 Particles > 1,0 mm
- 5 Dust protected
- 6 Dust tight

Second digit is the degree of protection according to IEC 60529 (approximate)

Protection against wet conditions (fluids)

- 0 Not protected
- 1 Falling water drops - vertical
- 2 Falling water drops - tilted < 15°
- 3 Spray water < 60°
- 4 Water splashing from all directions
- 5 Water jets from all directions
- 6 Powerful water jets
- 7 Temporary immersion in water
- 8 Continuous immersion in water



**Example:** IP67 means that the product is dust tight and is protected against temporary immersion in water.



# MarCal. The new Generation

WATERPROOF DIGITAL CALIPERS WITH THE REFERENCE SYSTEM AND INTEGRATED WIRELESS

## Security due to the Reference-Lock function

- Zero-position is secured
- Operating error is not possible

The digital caliper MarCal 16 EWRI Reference is equipped with a LOCK function. With this key lock, the zero position is secured and operating error is avoided.



## Battery service life is 3 years

The new Reference System is extremely energy efficient because of its standby mode feature; almost no power is required, thus **extending the life of the battery up to 3 years\***.

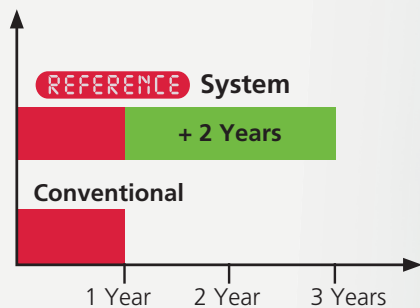

\* When Integrated Wireless is deactivated

## Superior quality of the guideways

Only MarCal calipers have lapped guideway surfaces, that guarantee an even and sensitive run of the slide. Additionally, the service life of the caliper increases, compared to a ground guideway due to the greater contact area on the guideway surface.



### Surface of the guideway

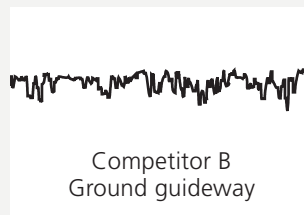
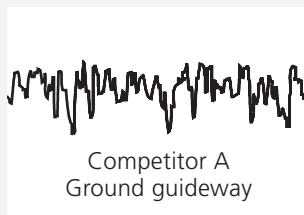
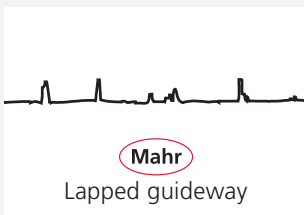





## MarConnect Integrated Wireless



**Wireless data transmission for the price of a data cable.** With Mahr's Integrated Wireless, users have a new Integrated Wireless data transmission system for the price of a data cable. Data acquisition with digital calipers is now even simpler: simply transmit your measured data directly into Microsoft Office Excel® or any Windows program with a keyboard code.

## Secure data transmission



With Integrated Wireless, your data will be transferred to the digital indicator, which is confirmed with a message in the digital indicator's display. The message will show whether the sent data has been transferred correctly, and/or whether you are in the reception range of the i-Stick.



## Ergonomic Design

The handy non-slip thumb support of the MarCal 16 EWRi ensures, even in contaminated working conditions, trouble-free handling and therefore reliable measuring results.



The high-contrast display with 11 mm sized digits enables accurate, fatigue-free reading of the measurement results.

## Excellent resistance against dust, coolant and lubricants



Due to the outstanding protection against dust and water, the digital caliper MarCal 16 EWRi Reference delivers precise and secure results, even in the most difficult workshop conditions. The finished plastic components have an outstanding chemical resistance.



Code Initials	<b>IP</b>	International Protection
First digit	<b>6</b>	Dust-tight
Second digit	<b>7</b>	Protected against temporary immersion in water



# Digital Caliper MarCal 16 EWRI

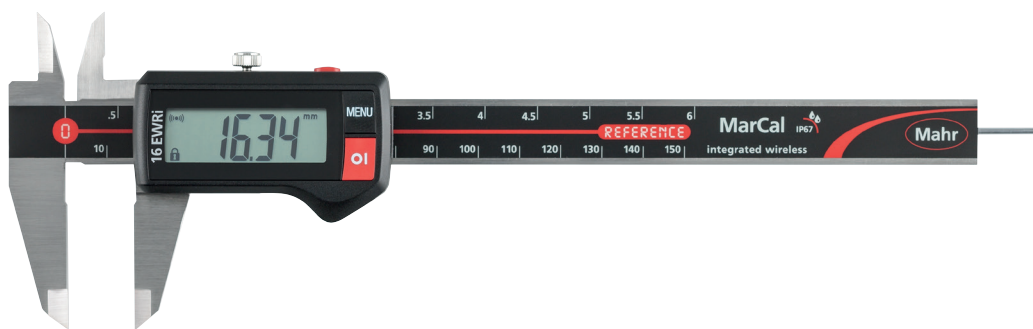

## Functions:

- ON/OFF
- AUTO-ON / OFF
- HOLD (storage of measured values)
- RESET (set display to zero)
- PRESET (for entering a numerical value)
- Reversal of counting direction
- mm/inch
- LOCK function (key lock)
- DATA (data transmission)

- High contrast analog display
- Locking screw above
- Lapped guideway
- Measuring blade for inside measurements
- Slide and beam made of hardened stainless steel
- Step measuring function
- Immediate measurements due to the Reference System

- Raised guideways for the protection of the scale
- Excellent resistance against dust, coolants and lubricants

- Dirt wipers are integrated in the slide

- **Software:** MarCom Professional free download: [www.mahr.com/marcom](http://www.mahr.com/marcom) (only for Mahr data cables and wireless systems with USB and RS232 interface)

- **Digit height:** 11 mm

- **Data interface:** Integrated wireless

- **Energy supply:** Battery life approx. 3 years (approx. 0,5 in wireless mode)

- **IP protection category:** IP 67

- **Scope of delivery:** Battery, Instruction manual, Case

## Technical Data

Order no.	Product type	Measuring range		Resolution	Error limit		Standard	Depth Rod	Friction wheel
		mm	inch		mm	inch			
4103400	16 EWRI	0 – 150	0 – 6"	0,01 / .0005"	0,03	.001"	DIN 862	round	
4103401	16 EWRI	0 – 150	0 – 6"	0,01 / .0005"	0,03	.001"	DIN 862	round	•
4103402	16 EWRI	0 – 150	0 – 6"	0,01 / .0005"	0,03	.001"	DIN 862	rectangular	
4103403	16 EWRI	0 – 150	0 – 6"	0,01 / .0005"	0,03	.001"	DIN 862	rectangular	•
4103404	16 EWRI	0 – 200	0 – 8"	0,01 / .0005"	0,03	.001"	DIN 862	rectangular	
4103405	16 EWRI	0 – 200	0 – 8"	0,01 / .0005"	0,03	.001"	DIN 862	rectangular	•
4103406	16 EWRI	0 – 300	0 – 12"	0,01 / .0005"	0,04	.0015"	Factory standard		
4103407	16 EWRI	0 – 300	0 – 12"	0,01 / .0005"	0,04	.0015"	Factory standard		•

Order no.	a	b	c	d	e
	mm	mm	mm	mm	mm
4103400	10	40	16	235	16
4103401	10	40	16	235	16
4103402	10	40	16	235	16
4103403	10	40	16	235	16
4103404	10	50	19	285	16
4103405	10	50	19	285	16
4103406	14	64	19	388	16
4103407	14	64	19	388	16

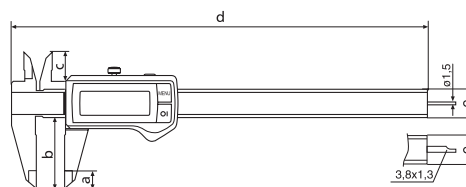

## Accessories

Order no.	Product description	Product type
4102020	Depth bridge (75 x 7 mm)	16 Em
4102220	Receiver	i-Stick
4102520	Battery 3 V, CR 2032	

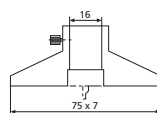

16 Em



i-Stick



# Digital Caliper MarCal 16 EWR

## Functions:

- ON/OFF
- AUTO-ON / OFF
- RESET (set display to zero)
- PRESET (for entering a numerical value)
- Reversal of counting direction
- mm/inch
- LOCK function (key lock)
- High contrast analog display
- Locking screw above
- Lapped guideway
- Measuring blade for inside measurements
- Slide and beam made of hardened stainless steel
- Step measuring function
- Immediate measurements due to the Reference System
- Raised guideways for the protection of the scale
- Excellent resistance against dust, coolants and lubricants
- Dirt wipers are integrated in the slide
- **Digit height:** 11 mm
- **Energy supply:** Battery life approx. 3 years
- **IP protection category:** IP 67
- **Scope of delivery:** Battery, Instruction manual, Case

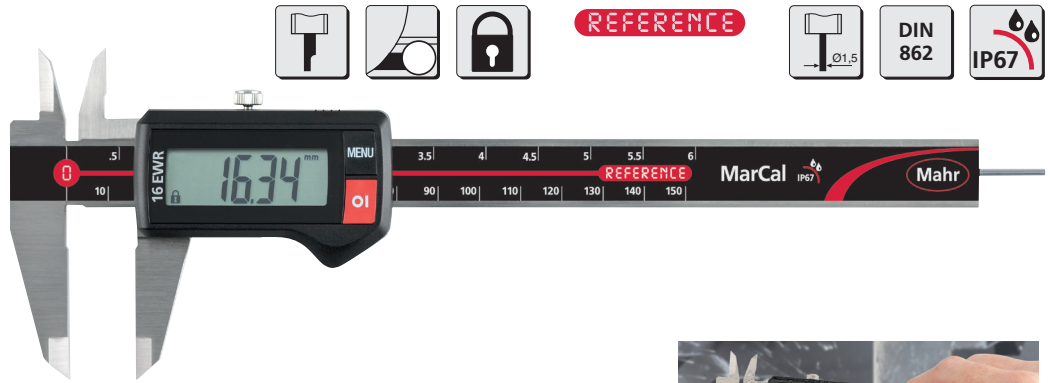

## Technical Data

Order no.	Product type	Measuring range		Resolution	Error limit		Standard	Depth Rod	Friction wheel
		mm	inch		mm	inch			
4103300	16 EWR	0 - 150	0 - 6"	0,01 / .0005"	0,03	.001"	DIN 862	round	
4103301	16 EWR	0 - 150	0 - 6"	0,01 / .0005"	0,03	.001"	DIN 862	round	•
4103302	16 EWR	0 - 150	0 - 6"	0,01 / .0005"	0,03	.001"	DIN 862	rectangular	
4103303	16 EWR	0 - 150	0 - 6"	0,01 / .0005"	0,03	.001"	DIN 862	rectangular	•

Order no.	a	b	c	d	e
	mm	mm	mm	mm	mm
4103300	10	40	16	235	16
4103301	10	40	16	235	16
4103302	10	40	16	235	16
4103303	10	40	16	235	16

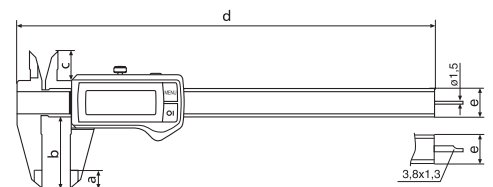

## Accessories

Order no.	Product description	Product type
4102020	Depth bridge (75 x 7 mm)	16 Em
4102520	Battery 3 V, CR 2032	

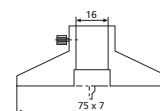

16 Em



# Digital Caliper MarCal 16 EWR



REFERENCE

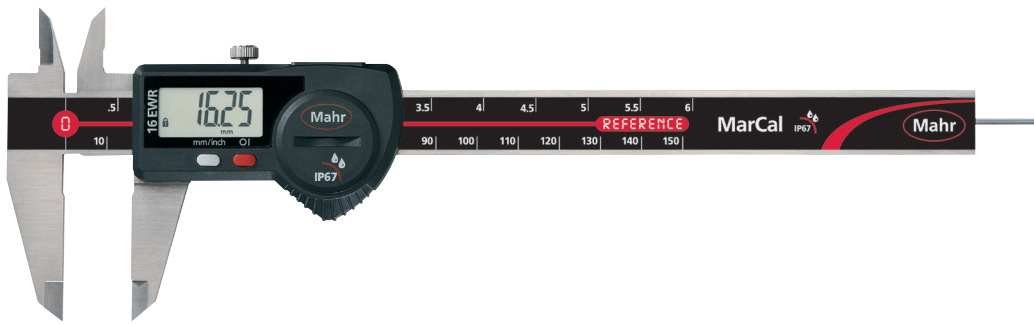

### Functions:

- ON/OFF
- AUTO-ON / OFF
- RESET (set display to zero)
- mm/inch
- LOCK function (key lock)
- DATA (Data transmission via connection cable)
- High contrast analog display
- Locking screw above
- Lapped guideway
- Measuring blade for inside measurements
- Slide and beam made of hardened stainless steel
- Step measuring function
- Immediate measurements due to the Reference System
- Raised guideways for the protection of the scale
- Excellent resistance against dust, coolants and lubricants
- Dirt wipers are integrated in the slide
- **Software:** MarCom Professional free download: [www.mahr.com/marcom](http://www.mahr.com/marcom) (only for Mahr data cables and wireless systems with USB and RS232 interface)
- **Digit height:** 8.5 mm
- **Data interface:** USB, Opto RS232C, Digimatic
- **Energy supply:** Battery life approx. 3 years
- **IP protection category:** IP 67
- **Scope of delivery:** Battery, Instruction manual, Case

## Technical Data

Order no.	Product type	Measuring range		Resolution	Error limit	Error limit	Standard	Depth Rod	Friction wheel
		mm	inch						
4103064	16 EWR	0 – 150	0 – 6"	0,01 / .0005"	0,03	.001"	DIN 862	round	
4103065	16 EWR	0 – 150	0 – 6"	0,01 / .0005"	0,03	.001"	DIN 862	round	•
4103066	16 EWR	0 – 150	0 – 6"	0,01 / .0005"	0,03	.001"	DIN 862	rectangular	
4103067	16 EWR	0 – 150	0 – 6"	0,01 / .0005"	0,03	.001"	DIN 862	rectangular	•
4103068	16 EWR	0 – 200	0 – 8"	0,01 / .0005"	0,03	.001"	DIN 862	rectangular	
4103069	16 EWR	0 – 200	0 – 8"	0,01 / .0005"	0,03	.001"	DIN 862	rectangular	•
4103070	16 EWR	0 – 300	0 – 12"	0,01 / .0005"	0,04	.0015"	Factory standard		
4103071	16 EWR	0 – 300	0 – 12"	0,01 / .0005"	0,04	.0015"	Factory standard		•

Order no.	a	b	c	d	e
	mm	mm	mm	mm	mm
4103064	10	40	16	235	16
4103065	10	40	16	235	16
4103066	10	40	16	235	16
4103067	10	40	16	235	16
4103068	10	50	19	285	16
4103069	10	50	19	285	16
4103070	14	64	19	388	16
4103071	14	64	19	388	16

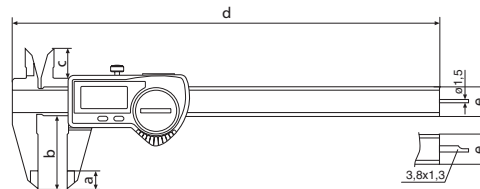

## Accessories

Order no.	Product description	Product type
4102020	Depth bridge (75 x 7 mm)	16 Em
4102357	Data Connection Cable USB (2 m)	16 EXu
4102410	Data Connection Cable RS232C (2 m)	16 EXr
4102520	Battery 3 V, CR 2032	
4102915	Digimatic data cable (2 m)	16 EWd

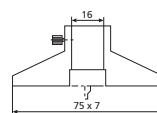

16 Em



# Digital Caliper MarCal 16 ER

## Functions:

- ON/OFF
- AUTO-ON / OFF
- RESET (set display to zero)
- mm/inch
- LOCK function (key lock)
- High contrast analog display
- Locking screw above
- Lapped guideway
- Measuring blade for inside measurements
- Slide and beam made of hardened stainless steel
- Step measuring function
- Immediate measurements due to the Reference System
- Raised guideways for the protection of the scale
- Dirt wipers are integrated in the slide
- **Digit height:** 11 mm
- **Energy supply:** Battery life approx. 3 years
- **IP protection category:** none
- **Scope of delivery:** Instruction manual, Battery, Case

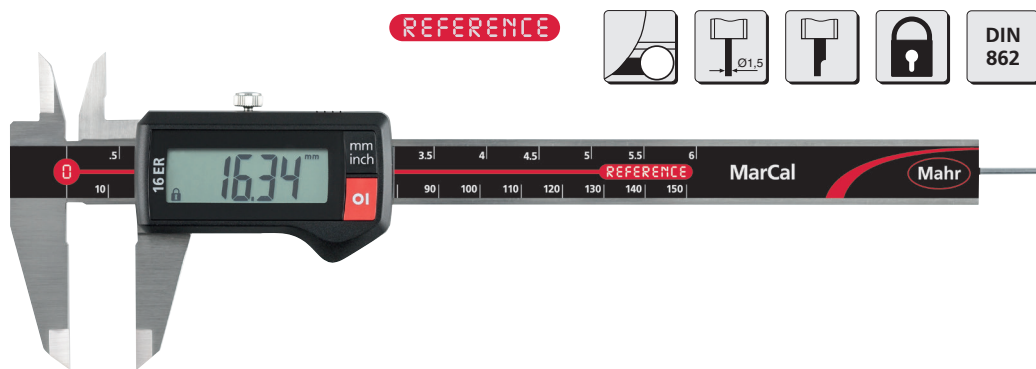

REFERENCE



DIN 862

## Technical Data

Order no.	Product type	Measuring range		Resolution	Error limit		Standard	Depth Rod	Friction wheel
		mm	inch		mm	inch			
4103010	16 ER	0 - 150	0 - 6"	0,01 / .0005"	0,03	.001"	DIN 862	round	
4103011	16 ER	0 - 150	0 - 6"	0,01 / .0005"	0,03	.001"	DIN 862	round	•
4103012	16 ER	0 - 150	0 - 6"	0,01 / .0005"	0,03	.001"	DIN 862	rectangular	
4103013	16 ER	0 - 150	0 - 6"	0,01 / .0005"	0,03	.001"	DIN 862	rectangular	•

Order no.	a	b	c	d	e
	mm	mm	mm	mm	mm
4103010	10	40	16	235	16
4103011	10	40	16	235	16
4103012	10	40	16	235	16
4103013	10	40	16	235	16

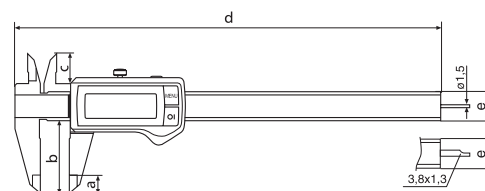

## Accessories

Order no.	Product description	Product type
4102020	Depth bridge (75 x 7 mm)	16 Em
4102520	Battery 3 V, CR 2032	

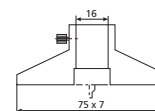

16 Em





# Digital Caliper MarCal 16 ER

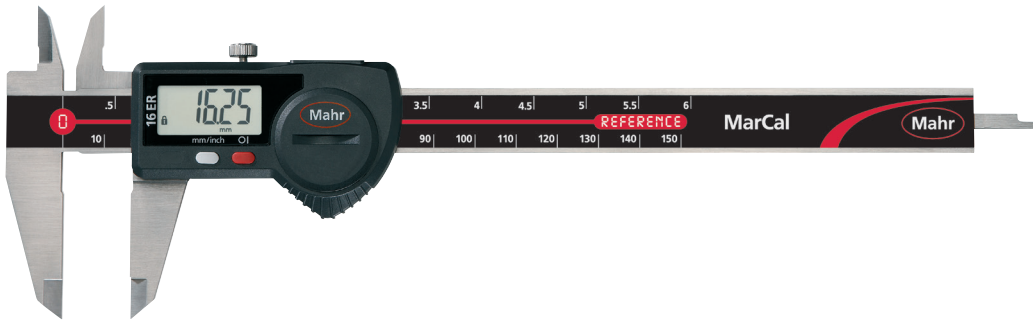
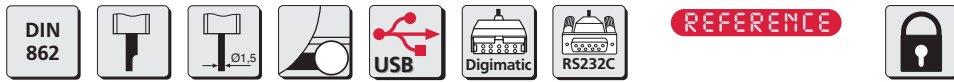

- Functions:**
- ON/OFF
  - AUTO-ON / OFF
  - RESET (set display to zero)
  - mm/inch
  - LOCK function (key lock)
  - DATA (Data transmission via connection cable)
- High contrast analog display
  - Locking screw above
  - Lapped guideway
  - Measuring blade for inside measurements
  - Slide and beam made of hardened stainless steel
  - Step measuring function
  - Immediate measurements due to the Reference System
  - Raised guideways for the protection of the scale
  - Dirt wipers are integrated in the slide
- **Software:** MarCom Professional free download: [www.mahr.com/marcom](http://www.mahr.com/marcom) (only for Mahr data cables and wireless systems with USB and RS232 interface)
  - **Digit height:** 8,5 mm
  - **Data interface:** USB, Opto RS232C, Digimatic
  - **Energy supply:** Battery life approx. 3 years
  - **IP protection category:** none
  - **Scope of delivery:** Instruction manual, Battery, Case

## Technical Data

Order no.	Product type	Measuring range		Resolution	Error limit		Standard	Depth Rod	Friction wheel
		mm	inch		mm/inch	mm			
4103014	16 ER	0 – 150	0 – 6"	0,01 / .0005"	0,03	.001"	DIN 862	round	
4103015	16 ER	0 – 150	0 – 6"	0,01 / .0005"	0,03	.001"	DIN 862	round	•
4103016	16 ER	0 – 150	0 – 6"	0,01 / .0005"	0,03	.001"	DIN 862	rectangular	
4103017	16 ER	0 – 150	0 – 6"	0,01 / .0005"	0,03	.001"	DIN 862	rectangular	•
4103018	16 ER	0 – 200	0 – 8"	0,01 / .0005"	0,03	.001"	DIN 862	rectangular	
4103019	16 ER	0 – 200	0 – 8"	0,01 / .0005"	0,03	.001"	DIN 862	rectangular	•
4103020	16 ER	0 – 300	0 – 12"	0,01 / .0005"	0,04	.0015"	Factory standard		
4103021	16 ER	0 – 300	0 – 12"	0,01 / .0005"	0,04	.0015"	Factory standard		•

Order no.	a	b	c	d	e
	mm	mm	mm	mm	mm
4103014	10	40	16	235	16
4103015	10	40	16	235	16
4103016	10	40	16	235	16
4103017	10	40	16	235	16
4103018	10	50	19	285	16
4103019	10	50	19	285	16
4103020	14	64	19	388	16
4103021	14	64	19	388	16

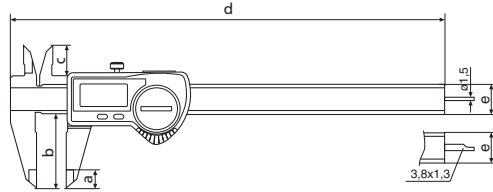

## Accessories

Order no.	Product description	Product type
4102020	Depth bridge (75 x 7 mm)	16 Em
4102357	Data Connection Cable USB (2 m)	16 EXu
4102410	Data Connection Cable RS232C (2 m)	16 EXr
4102520	Battery 3 V, CR 2032	
4102915	Digimatic data cable (2 m)	16 EWd

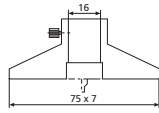

16 Em

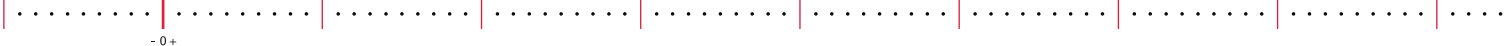



## Dial Caliper MarCal 16 U

- Large, high contrast dial face
- Satin chrome finished line scale
- Locking screw above
- Measuring surfaces made of steel
- Measuring blade for inside measurements
- Slide and beam made of hardened stainless steel
- Step measuring function
- **Scope of delivery:** Case

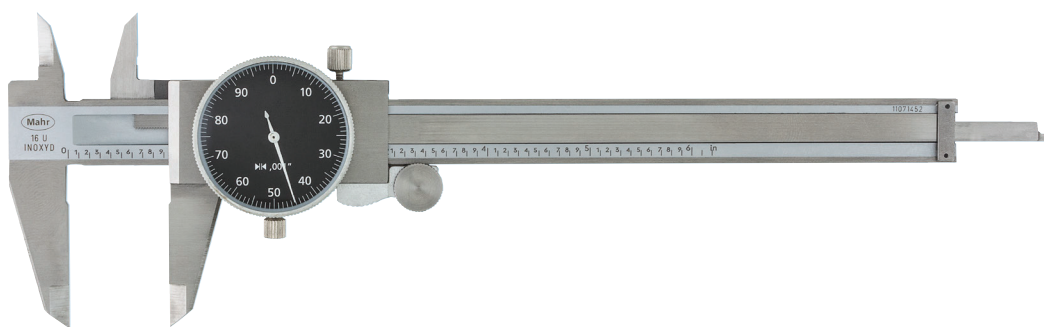

### Technical Data

Order-no.		4107005	4107107	4107900
Product type		16 U		
Measuring range	mm	0 – 150		
Measuring range	inch	0 – 6"		
Graduation value	mm	0,01	0,02	
Graduation value	inch	.0001"		
Range per rev.	inch	.100"		
Range per rev.	mm	1	2	
Error limit	mm	0,03		
Error limit	inch	.0012"		
Standard		DIN 862		Factory standard
Dial color		white		black
Depth Rod		rectangular		
Friction wheel		•		

Order no.	a	b	c	d	e
	mm	mm	mm	mm	mm
4107005	10	40	16,5	234	16
4107900	10	40	16,5	234	16
4107107	10	40	16,5	234	16

### Accessories

Order no.	Product description	Product type
4100302	Case for measuring range 150 mm	
4102020	Depth bridge (75 x 7 mm)	16 Em



# Caliper with analog display MarCal 16 FN

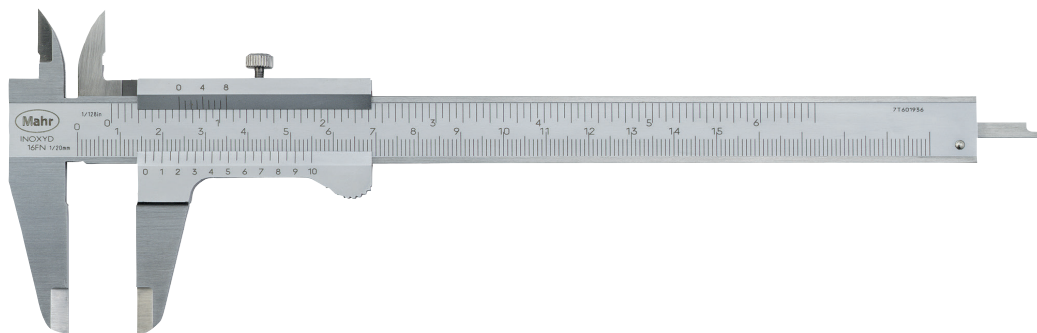

- Vernier and main scale have a satin chrome finish for glare free reading
- Locking screw above
- Measuring surfaces made of steel
- Measuring blade for inside measurements
- Slide and beam made of hardened stainless steel
- Step measuring function
- Raised guideways for the protection of the scale
- **Scope of delivery:** Thread table, Case

## Technical Data

Order no.	Product type	Measuring range		Readings	Vernier value		Error limit		Standard	Depth Rod
		mm	inch		mm	inch	mm	inch		
4100400	16 FN	0 – 150	0 – 6"	0,05	1/128"	0,05	.002"	DIN 862	rectangular	
4100401	16 FN	0 – 200	0 – 8"	0,05	1/128"	0,05	.002"	DIN 862	rectangular	
4100402	16 FN	0 – 300	0 – 12"	0,05	1/128"	0,05	.002"	DIN 862	rectangular	
4100420	16 FN	0 – 150		0,05		0,05		DIN 862	rectangular	
4100421	16 FN	0 – 200		0,05		0,05		DIN 862	rectangular	
4100422	16 FN	0 – 300		0,05		0,05		DIN 862	rectangular	

Order no.	a	b	c	d	e	f
	mm	mm	mm	mm	mm	mm
4100400	10	40	16	228	16	3,8
4100401	14	50	19	290	17	3,8
4100402	16	64	23	404	20	4,8
4100420	10	40	16	228	16	3,8
4100421	14	50	19	290	17	3,8
4100422	16	64	23	404	20	4,8

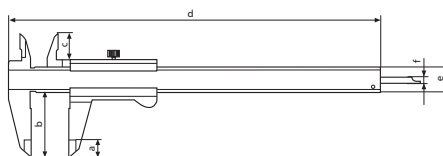

## Accessories

Order no.	Product description	Product type
4100302	Case for measuring range 150 mm	
4102020	Depth bridge (75 x 7 mm)	16 Em

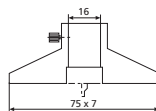

16 Em



# Caliper with analog display MarCal 16 GN



- Vernier and main scale have a satin chrome finish for glare free reading
- Locking screw above
- Measuring surfaces made of steel
- Measuring blade for inside measurements
- Slide and beam made of hardened stainless steel
- Step measuring function
- Raised guideways for the protection of the scale
- **Scope of delivery:** Thread table, Case

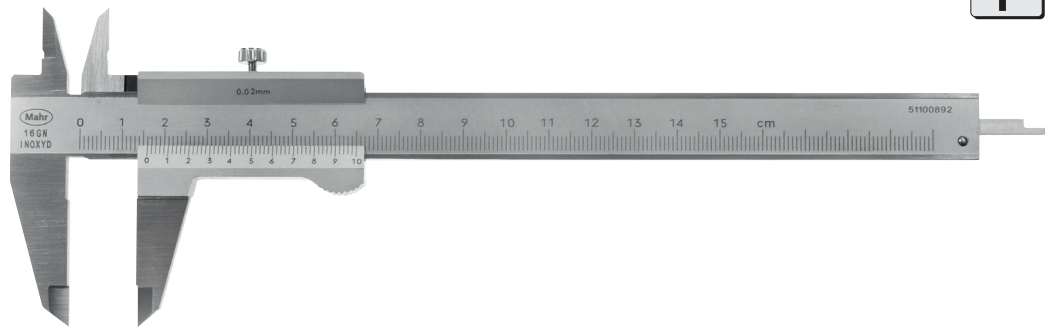

## Technical Data

Order no.	Product type	Measuring range	Measuring range	Readings	Vernier value	Error limit	Error limit	Standard	Depth Rod
		mm	inch	mm	inch	mm	inch		
4100650	16 GN	0 – 150		0,02		0,05		Factory standard	rectangular
4100651	16 GN	0 – 200		0,02		0,05		Factory standard	rectangular
4100652	16 GN	0 – 300		0,02		0,05		Factory standard	rectangular
4100671	16 GN	0 – 200	0 – 8"	0,02	.001"	0,05	.002"	Factory standard	rectangular
4100672	16 GN	0 – 300	0 – 12"	0,02	.001"	0,05	.002"	Factory standard	rectangular

Order no.	a	b	c	d	e	f
	mm	mm	mm	mm	mm	mm
4100650	10	40	16	228	16	3,8
4100651	14	50	19	290	17	3,8
4100652	16	64	23	404	20	4,8
4100671	14	50	19	290	17	3,8
4100672	16	64	23	404	20	4,8

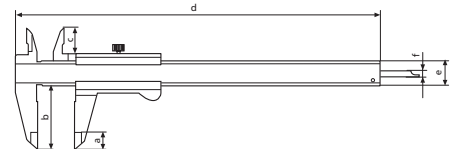

## Accessories

Order no.	Product description	Product type
4100302	Case for measuring range 150 mm	
4102020	Depth bridge (75 x 7 mm)	16 Em

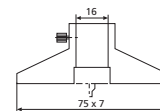

16 Em



# Caliper with analog display MarCal 16 N

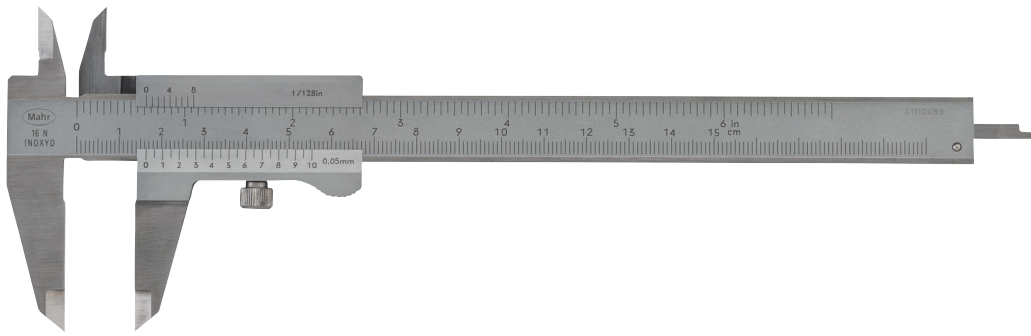

- Vernier and main scale have a satin chrome finish for glare free reading
- Locking screw below
- Measuring surfaces made of steel
- Measuring blade for inside measurements
- Slide and beam made of hardened stainless steel
- Step measuring function
- **Scope of delivery:** Thread table, Case

## Technical Data

Order no.	Product type	Measuring range	Measuring range	Readings	Vernier value	Error limit	Error limit	Standard	Depth Rod
		mm	inch	mm	inch	mm	inch		
4100500	16 N	0 – 150	0 – 6"	0,05	1/128"	0,05	.002"	DIN 862	rectangular

Order no.	a	b	c	d	e	f
	mm	mm	mm	mm	mm	mm
4100500	10	40	16	228	16	3,8

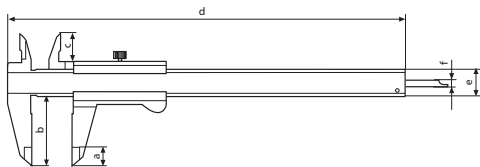

## Accessories

Order no.	Product description	Product type
4100302	Case for measuring range 150 mm	
4102020	Depth bridge (75 x 7 mm)	16 Em

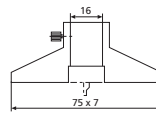

16 Em





# Caliper with analog display MarCal 16 DN

- Vernier and main scale have a satin chrome finish for glare free reading
- Thumb clamp
- Measuring surfaces made of steel
- Measuring blade for inside measurements
- Slide and beam made of hardened stainless steel
- Step measuring function
- Raised guideways for the protection of the scale
- **Scope of delivery:** Thread table, Case



DIN 862

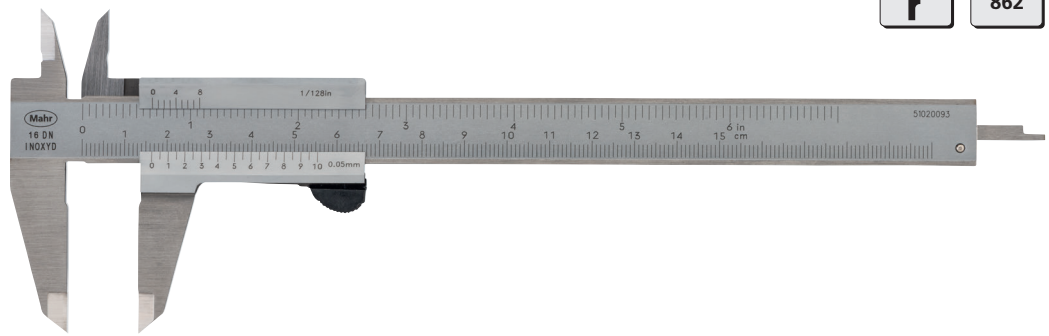

## Technical Data

Order no.	Product type	Measuring range	Measuring range	Readings	Vernier value	Error limit	Error limit	Standard	Depth Rod
		mm	inch	mm	inch	mm	inch		
4100600	16 DN	0 – 150	0 – 6"	0,05	1/128"	0,05	.002"	DIN 862	rectangular

Order no.	a	b	c	d	e	f
	mm	mm	mm	mm	mm	mm
4100600	10	40	16	228	16	3,8

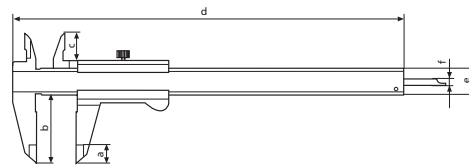

## Accessories

Order no.	Product description	Product type
4100302	Case for measuring range 150 mm	
4102020	Depth bridge (75 x 7 mm)	16 Em

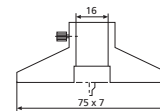

16 Em



# Digital universal caliper MarCal 16 EWRI-V

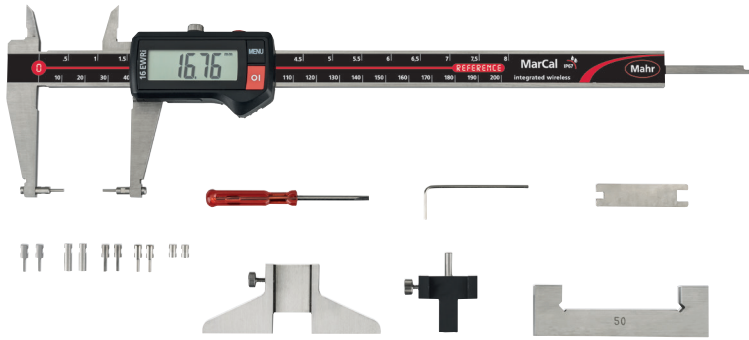

## Application:

- Can be used as a standard caliper (four types of measurements)
- With standard accessories to measure recesses, grooves, etc.
- With additional accessories to measure threads, bores, serrations



## Technical Data

Order no.	Product type	Measuring range		Resolution	Error limit		Standard	Depth Rod	Incl. accessories
		mm	inch		mm/inch	mm			
4118907	16 EWRI-V	0 - 200	0 - 8"	0,01 / .0005"	0,03	.001"	DIN 862	rectangular	•

Order no.	b	c	d	e
4118907	48	16,5	285	16

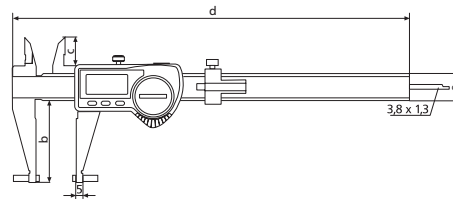

## Accessories

Order no.	Product description	Product type
4102020	Depth bridge (75 x 7 mm)	16 Em
4102220	Receiver	i-Stick
4102520	Battery 3 V, CR 2032	
4118810	Anvil for outside measurement (3,5 x 12 mm)	16 Eea 1
4118811	Anvil for outside measurement (1,5 x 6 mm)	16 Eea 2
4118812	Anvil for outside measurement (3,5 x 6 mm)	16 Eea 3
4118813	Anvil for inside measurement (3,5 x 6 mm)	16 Eei 1
4118814	Anvil for inside measurement (1,5 x 6 mm)	16 Eei 2
4118815	Anvil for inside measurement (3,5 x 6 mm)	16 Eei 3
4118816	Anvil for inside measurement (4 x 2,5 mm)	16 Eei 4
4118817	Setting Gage for inside measurement (50 mm)	16 Eel
4118818	Measuring Force Device	16 Ec
4118819	Mounting Attachment for thread anvils 844 TG/844Tr and ball anvils 844 Tk	16 Eab
4879602	Screws M2x8	



i-Stick

16 Em

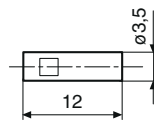

16 Eea 1

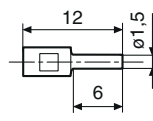

16 Eea 2

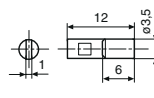

16 Eei 1

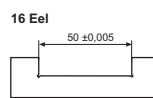

16 Eei 2

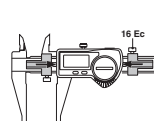

16 Eei 3

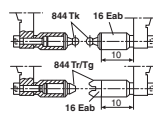

16 Eei 4



16 Ec

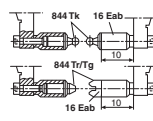

16 Eab

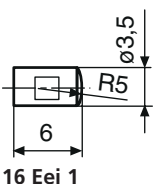

16 Eei 1

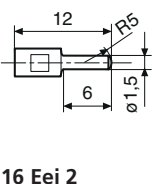

16 Eei 2

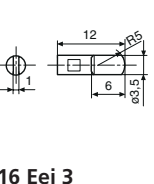

16 Eei 3

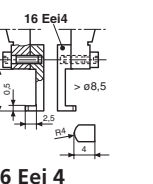

16 Eei 4

## Functions:

- AUTO-ON / OFF
- ON/OFF
- DATA (Data transmission via connection cable)
- HOLD (storage of measured values)
- PRESET (for entering a numerical value)
- RESET (set display to zero)
- mm/inch
- LOCK function (key lock)

- High contrast analog display
- Locking screw above
- Lapped guideway
- Measuring blade for inside measurements
- Slide and beam made of hardened stainless steel
- Step measuring function
- Immediate measurements due to the Reference System
- Raised guideways for the protection of the scale
- Excellent resistance against dust, coolants and lubricants
- Dirt wipers are integrated in the slide

- **Software:** MarCom Professional free download: [www.mahr.com/marcom](http://www.mahr.com/marcom) (only for Mahr data cables and wireless systems with USB and RS232 interface)

- **Digit height:** 11 mm

- **Data interface:** Integrated wireless

- **Energy supply:** Battery life approx. 3 years (approx. 0,5 in wireless mode)

- **IP protection category:** IP 67

- **Scope of delivery:** Battery, Instruction manual, Case, Setting gage for inside measurement 16 Eel, Measuring force device 16 Ec, Depth Measuring Bridge 16 Em, Anvils for outside measurement 16 Eea 1-3, Anvils for inside measurement 16 Eei 1-3



# Digital universal caliper MarCal 16 EWR-V



REFERENCE



DIN 862



## Functions:

- AUTO-ON / OFF
- DATA (Data transmission via connection cable)
- ON/OFF
- PRESET (for entering a numerical value)
- RESET (set display to zero)
- mm/inch
- LOCK function (key lock)

- High contrast analog display
- Locking screw above
- Lapped guideway
- Measuring blade for inside measurements
- Slide and beam made of hardened stainless steel
- Step measuring function
- Immediate measurements due to the Reference System
- Raised guideways for the protection of the scale
- Excellent resistance against dust, coolants and lubricants
- Dirt wipers are integrated in the slide

• **Software:** MarCom Professional free download:

[www.mahr.com/marcom](http://www.mahr.com/marcom)

(only for Mahr data cables and wireless systems with USB and RS232 interface)

• **Digit height:** 8.5 mm

• **Data interface:** USB, Opto RS232C, Digimatic, Wireless

• **Energy supply:** Battery life approx. 3 years

• **IP protection category:** IP 67

• **Scope of delivery:** Battery, Instruction manual, Case, Setting gage for inside measurement 16 Eel, Measuring force device 16 Ec, Depth Measuring Bridge 16 Em, Anvils for outside measurement 16 Eea 1-3, Anvils for inside measurement 16Eei 1-3, 4118808 without measuring anvils, adjustment bridge and measuring force equipment



## Application:

- Can be used as a standard caliper (four types of measurements)
- With standard accessories to measure recesses, grooves, etc.
- With additional accessories to measure threads, bores, serrations

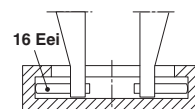
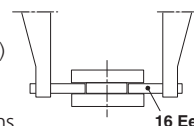

## Technical Data

Order no.	Product type	Measuring range mm	Measuring range inch	Resolution mm/inch	Error limit mm	Error limit inch	Standard	Depth Rod	Incl. accessories
4118807	16 EWR-V	0 - 200	0 - 8"	0,01 / .0005"	0,03	.001"	DIN 862	rectangular	•
4118808	16 EWR-V	0 - 200	0 - 8"	0,01 / .0005"	0,03	.001"	DIN 862	rectangular	

Order no.	b mm	c mm	d mm	e mm
4118807	48	16,5	285	16
4118808	48	16,5	285	16

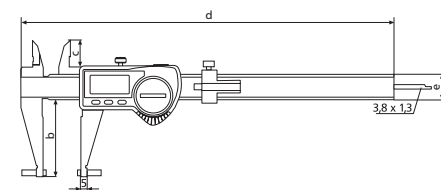

## Accessories

Order no.	Product name	Product type
4102020	Depth bridge (75 x 7 mm)	16 Em
4102357	16 EXu Data Connection Cable USB (2 m)	16 EXu
4102410	Data Connection Cable RS232C (2 m)	16 EXr
4102520	Battery 3 V, CR 2032	
4102915	Digimatic data cable (2 m)	16 EWd
4118810	Anvil for outside measurement (3.5 x 12 mm)	16 Eea 1
4118811	Anvil for outside measurement (1.5 x 6 mm)	16 Eea 2
4118812	Anvil for outside measurement (3.5 x 6 mm)	16 Eea 3
4118813	Anvil for inside measurement (3.5 x 6 mm)	16 Eei 1
4118814	Anvil for inside measurement (1.5 x 6 mm)	16 Eei 2
4118815	Anvil for inside measurement (3.5 x 6 mm)	16 Eei 3
4118816	Anvil for inside measurement (4 x 2.5 mm)	16 Eei 4
4118817	Setting Gage for inside measurement (50 mm)	16 Eel
4118818	Measuring Force Device	16 Ec
4118819	Mounting attachment for thread anvils 844 TG/844Tr and ball anvils 844 Tk	16 Eab
4879602	Screws M2x8	

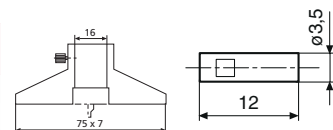

16 Em

16 Eea 1

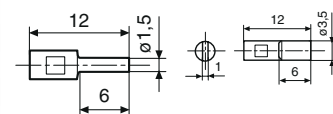

16 Eea 2

16 Eea 3

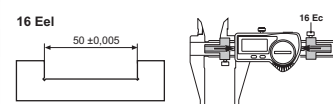

16 Eel

16 Ec

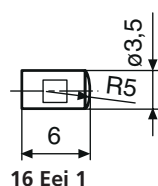

16 Eei 1

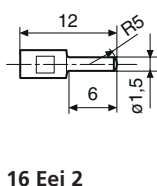

16 Eei 2

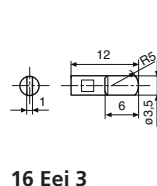

16 Eei 3

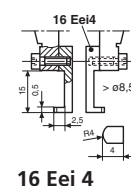

16 Eei 4

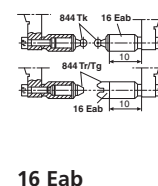

16 Eab



# Digital universal caliper MarCal 18 EWR-V



## Application:

- For inner and outer measurements of recesses, grooves, etc.
- Individual adjustment by means of measuring anvils with M2.5 thread

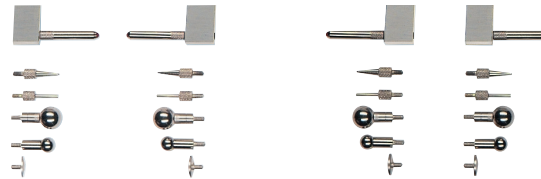

## Technical Data

Order no.	Product type	Measuring range		Resolution	Error limit		Standard
		mm	inch		mm	inch	
4112722	18 EWR-V	0 - 300	0 - 12"	0,01 / .0005"	0,06	.0025"	Factory standard
4112723	18 EWR-V	0 - 500	0 - 20"	0,01 / .0005"	0,08	.003"	Factory standard

Order no.	a	b	c	d	e
	mm	mm	mm	mm	mm
4112722	410	90	12	75,5	20
4112723	680	100	16	81	25

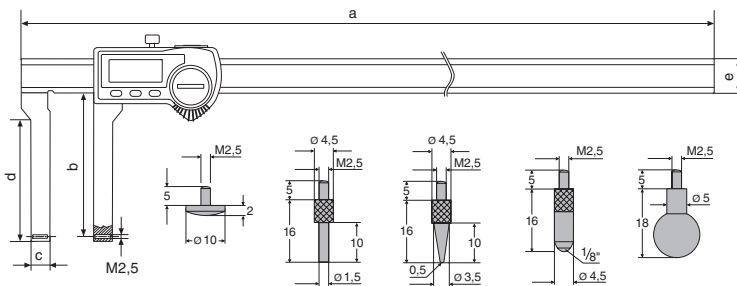

## Functions:

- ON/OFF
- AUTO-ON / OFF
- RESET (set display to zero)
- PRESET (for entering a numerical value)
- mm/inch
- LOCK function (key lock)
- DATA (Data transmission via connection cable)

- High contrast analog display
- Locking screw above
- Immediate measurements due to the Reference System
- Excellent resistance against dust, coolants and lubricants
- Dirt wipers are integrated in the slide
- Slide and beam made of hardened stainless steel
- Measuring faces for outside measurement
- Thread M2.5 measuring jaws to accommodate measuring anvils for internal and external measurements
- **Software:** MarCom Professional free download: [www.mahr.com/marcom](http://www.mahr.com/marcom) (only for Mahr data cables and wireless systems with USB and RS232 interface)
- **Digit height:** 10 mm (300 mm), 12,5 mm (500mm)
- **Data interface:** USB, Opto RS232C, Digimatic, Wireless
- **Energy supply:** Battery life approx. 3 years
- **IP protection category:** IP 65
- **Scope of delivery:** Battery, Case, Instruction manual, Avils

## Accessories

Order no.	Product description	Product type
4102230	Receiver	e-Stick
4102231	Transmitter for e-Stick	16 EWe
4102357	Data Connection Cable USB (2 m)	16 EXu
4102410	Data Connection Cable RS232C (2 m)	16 EXr
4102520	Battery 3 V, CR 2032	
4102915	Digimatic data cable (2 m)	16 EWd



16 EWe



e-Stick



# Digital Caliper for special applications MarCal 16 EWri-C / 16 EWR-C

## Functions 16 EWri-C:

- ON/OFF
- AUTO-ON / OFF
- mm/inch
- LOCK function (key lock)
- RESET (set display to zero)
- PRESET (for entering a numerical value)
- DATA (Data transmission)
- HOLD (storage of measured values)

## Functions 16 EWR-C:

- ON/OFF
- AUTO-ON / OFF
- mm/inch
- LOCK function (key lock)
- RESET (set display to zero)
- DATA (Data transmission via connection cable)

- High contrast analog display
- Locking screw above
- Lapped guideway
- Measuring blade for inside measurements
- Slide and beam made of hardened stainless steel
- Step measuring function
- Immediate measurements due to the Reference System
- Raised guideways for the protection of the scale
- Excellent resistance against dust, coolants and lubricants
- Dirt wipers are integrated in the slide

## Features 16 EWri-C:

- **Height of digits:** 11 mm
- **Data interface:** Integrated wireless
- **Energy supply:** Battery, life span ca. 3 years
- **IP protection category:** IP 67
- **Scope of delivery:** Battery, Instruction manual, Case

## Features 16 EWR-C:

- **Height of digits:** 8,5 mm
- **Data interface:** USB, Opto RS232C, Digimatic
- **Energy supply:** Battery, life span ca. 3 years
- **IP protection category:** IP 67
- **Scope of delivery:** Battery, Instruction manual, Case



## Application:

Outer measuring surfaces made of ceramic, for measuring hard materials

## Technical Data

Order no.	Product type	Measuring range		Resolution	Error limit		Standard	Depth Rod
		mm	inch		mm	inch		
4103372	16 EWri-C	0 – 150	0 – 6"	0,01 / .0005"	0,03	.001"	DIN 862	round
4103072	16 EWR-C	0 – 150	0 – 6"	0,01 / .0005"	0,03	.001"	DIN 862	round

Order no.	a	b	c	d	e
	mm	mm	mm	mm	mm
4103372	10	40	16	235	16
4103072	10	40	16	235	16

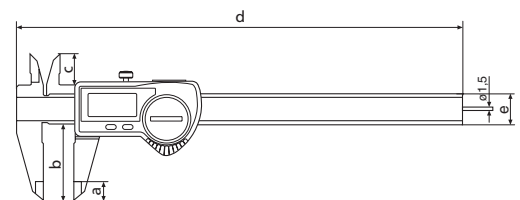

## Accessories

Order no.	For measuring instrument	Product description	Product type
4102220	16 EWri-C	Receiver	i-Stick
4102357	16 EWR-C	Data Connection Cable USB (2 m)	16 EXu
4102410	16 EWR-C	Data Connection Cable RS232C (2 m)	16 EXr
4102520	16 EWR-C, 16 EWri-C	Battery 3 V, CR 2032	
4102915	16 EWR-C	Digimatic data cable (2 m)	16 EWd



i-Stick





# Digital Caliper for special applications MarCal 16 EWri-H / 16 EWR-H

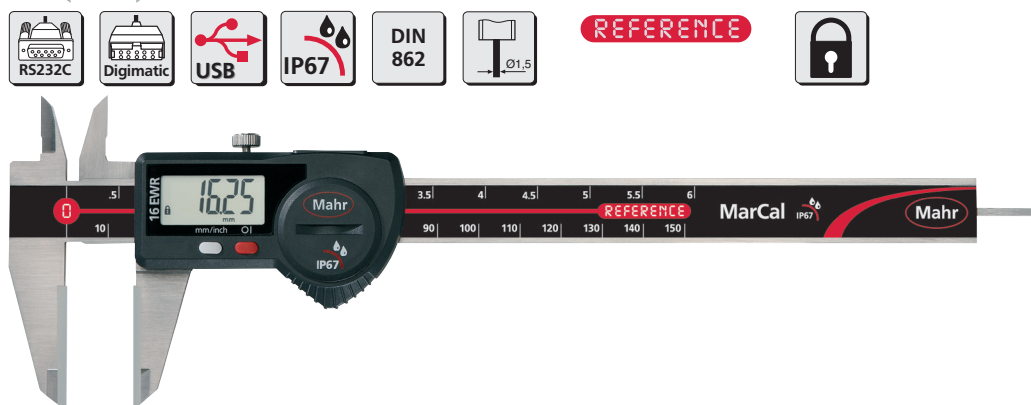

## Functions 16 EWri-H:

- ON/OFF
- AUTO-ON / OFF
- mm/inch
- LOCK function (key lock)
- RESET (set display to zero)
- PRESET (for entering a numerical value)
- DATA (Data transmission)
- HOLD (storage of measured values)

## Functions 16 EWR-H:

- ON/OFF
- AUTO-ON / OFF
- mm/inch
- LOCK function (key lock)
- RESET (set display to zero)
- DATA (Data transmission via connection cable)

### Application:

Outer measuring surfaces made of carbide, for measuring hard materials

- High contrast analog display
- Locking screw above
- Lapped guideway
- Measuring blade for inside measurements
- Slide and beam made of hardened stainless steel
- Step measuring function
- Immediate measurements due to the Reference System
- Raised guideways for the protection of the scale
- Excellent resistance against dust, coolants and lubricants
- Dirt wipers are integrated in the slide

### Technical Data

Order no.	Product type	Measuring range		Resolution	Error limit		Standard	Depth Rod
		mm	inch		mm/inch	mm		
4103373	16 EWri-H	0 - 150	0 - 6"	0,01 / .0005"	0,03	.001"	DIN 862	round
4103073	16 EWR-H	0 - 150	0 - 6"	0,01 / .0005"	0,03	.001"	DIN 862	round

Order no.	a	b	c	d	e
	mm	mm	mm	mm	mm
4103373	10	40	16	235	16
4103073	10	40	16	235	16

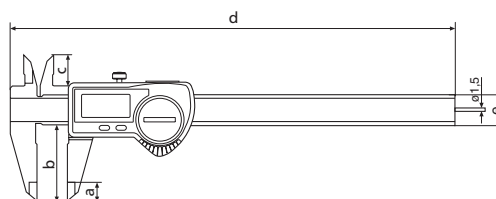

## Features 16 EWri-H:

- **Height of digits:** 11 mm
- **Data interface:** Integrated wireless
- **Energy supply:** Battery, life span ca. 3 years
- **IP protection category:** IP 67
- **Scope of delivery:** Battery, Instruction manual, Case

## Features 16 EWR-H:

- **Height of digits:** 8,5 mm
- **Data interface:** USB, Opto RS232C, Digimatic
- **Energy supply:** Battery, life span ca. 3 years
- **IP protection category:** IP 67
- **Scope of delivery:** Battery, Instruction manual, Case

### Accessories

Order no.	For measuring instrument	Product description	Product type
4102220	16 EWri-H	Receiver	i-Stick
4102357	16 EWR-H	Data Connection Cable USB (2 m)	16 EXu
4102410	16 EWR-H	Data Connection Cable RS232C (2 m)	16 EXr
4102520	16 EWR-H, 16 EWri-H	Battery 3 V, CR 2032	
4102915	16 EWR-H	Digimatic data cable (2 m)	16 EWd



i-Stick



# Digital Caliper for special applications MarCal 16 EWRI-AR / 16 EWR-AR

## Functions 16 EWRI-AR:

- ON/OFF
- AUTO-ON / OFF
- mm/inch
- LOCK function (key lock)
- RESET (set display to zero)
- PRESET (for entering a numerical value)
- DATA (Data transmission)
- HOLD (storage of measured values)



REFERENCE

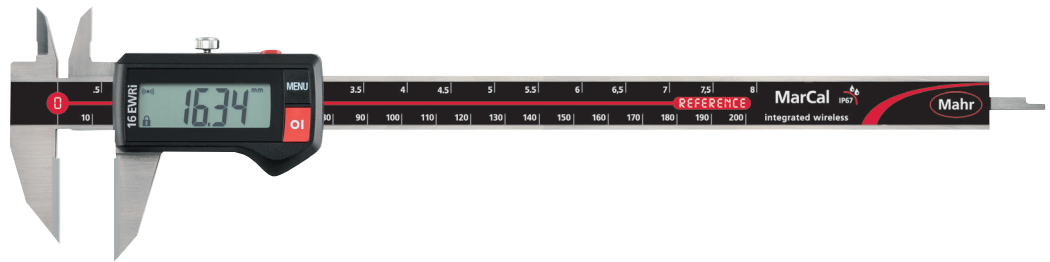

## Functions 16 EWR-AR:

- ON/OFF
- AUTO-ON / OFF
- mm/inch
- LOCK function (key lock)
- RESET (set display to zero)
- DATA (Data transmission via connection cable)



REFERENCE

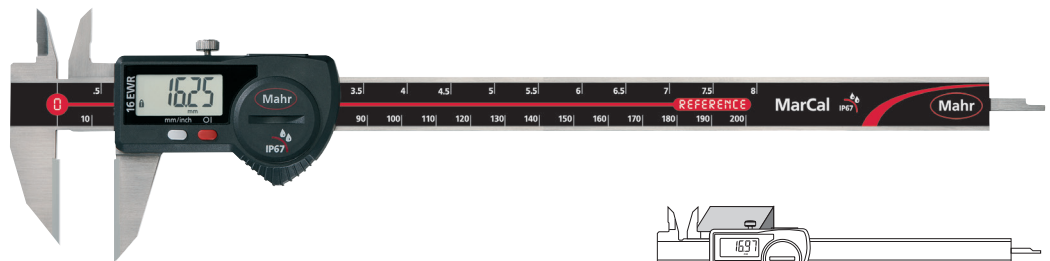

- High contrast analog display
- Locking screw above
- Lapped guideway
- Measuring blade for inside measurements
- Slide and beam made of hardened stainless steel
- Step measuring function
- Immediate measurements due to the Reference System
- Raised guideways for the protection of the scale
- Excellent resistance against dust, coolants and lubricants
- Dirt wipers are integrated in the slide

## Application:

For marking out workpieces

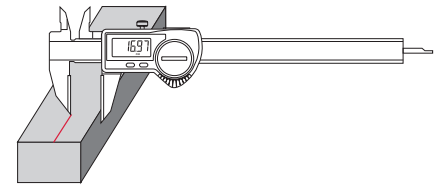

## Technical Data

Order no.	Product type	Measuring range		Resolution	Error limit		Standard	Depth Rod
		mm	inch		mm	inch		
4103382	16 EWRI-AR	0 – 200	0 – 8"	0,01 / .0005"	0,03	.001"	Factory standard	rectangular
4103082	16 EWR-AR	0 – 200	0 – 8"	0,01 / .0005"	0,03	.001"	Factory standard	rectangular

## Features 16 EWRI-AR:

- **Height of digits:** 11 mm
- **Data interface:** Integrated wireless
- **Energy supply:** Battery, life span ca. 3 years
- **IP protection category:** IP 67
- **Scope of delivery:** Battery, Instruction manual, Case

Order no.	c	d	e
	mm	mm	mm
4103382	16,5	285	16
4103082	16,5	285	16

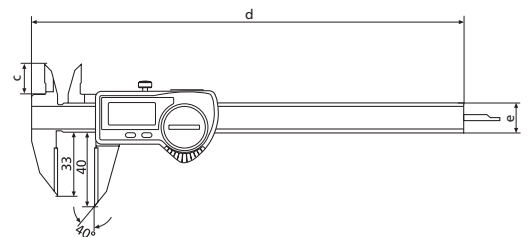

## Features 16 EWR-AR:

- **Height of digits:** 8,5 mm
- **Data interface:** USB, Opto RS232C, Digimatic
- **Energy supply:** Battery, life span ca. 3 years
- **IP protection category:** IP 67
- **Scope of delivery:** Battery, Instruction manual, Case

## Accessories

Order no.	For measuring instrument	Product description	Product type
4102220	16 EWRI-AR	Receiver	i-Stick
4102357	16 EWR-AR	Data Connection Cable USB (2 m)	16 EXu
4102410	16 EWR-AR	Data Connection Cable RS232C (2 m)	16 EXr
4102520	16 EWR-AR, 16 EWRI-AR	Battery 3 V, CR 2032	
4102915	16 EWR-AR	Digimatic data cable (2 m)	16 EWd



i-Stick



# Digital Caliper for special applications MarCal 16 EWri-NA / 16 EWR-NA

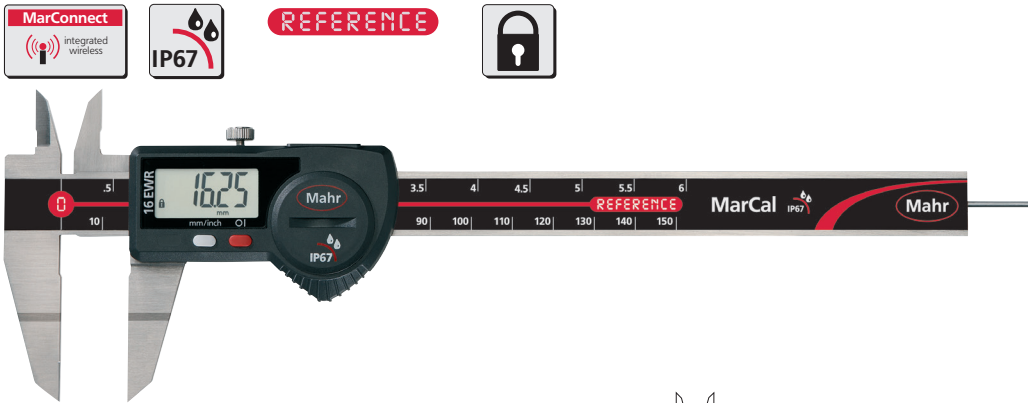
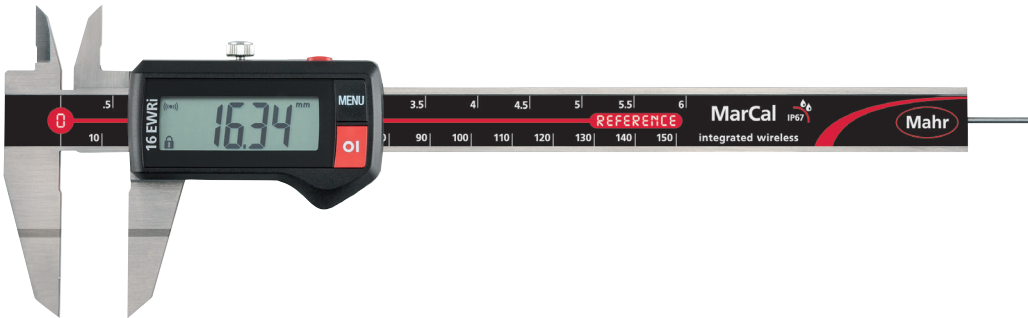

## Application:

For measuring keyseats

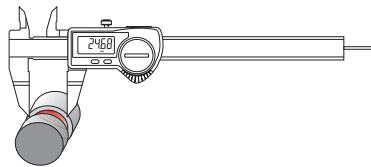

### Functions 16 EWri-NA:

- ON/OFF
- AUTO-ON / OFF
- mm/inch
- LOCK function (key lock)
- RESET (set display to zero)
- PRESET (for entering a numerical value)
- DATA (Data transmission)
- HOLD (storage of measured values)

### Functions 16 EWR-NA:

- ON/OFF
- AUTO-ON / OFF
- mm/inch
- LOCK function (key lock)
- RESET (set display to zero)
- DATA (Data transmission via connection cable)

- High contrast analog display
- Locking screw above
- Lapped guideway
- Measuring blade for inside measurements
- Slide and beam made of hardened stainless steel
- Step measuring function
- Immediate measurements due to the Reference System
- Raised guideways for the protection of the scale
- Excellent resistance against dust, coolants and lubricants
- Dirt wipers are integrated in the slide

## Technical Data

Order no.	Product type	Measuring range		Resolution	Error limit		Standard	Depth Rod
		mm	inch		mm	inch		
4103374	16 EWri-NA	0 - 150	0 - 6"	0,01 / .0005"	0,03	.001"	Factory standard	round
4103074	16 EWR-NA	0 - 150	0 - 6"	0,01 / .0005"	0,03	.001"	Factory standard	round

Order no.	a	b	c	d	e
	mm	mm	mm	mm	mm
4103374	20	40	16,5	235	16
4103074	20	40	16,5	235	16

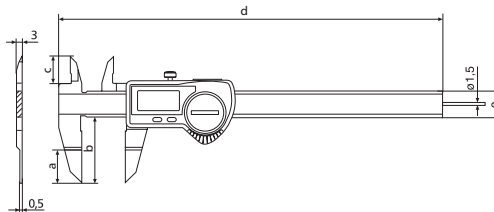

### Features 16 EWri-NA:

- **Height of digits:** 11 mm
- **Data interface:** Integrated wireless
- **Energy supply:** Battery, life span ca. 3 years
- **IP protection category:** IP 67
- **Scope of delivery:** Battery, Instruction manual, Case

### Features 16 EWR-NA:

- **Height of digits:** 8,5 mm
- **Data interface:** USB, Opto RS232C, Digimatic
- **Energy supply:** Battery, life span ca. 3 years
- **IP protection category:** IP 67
- **Scope of delivery:** Battery, Instruction manual, Case

## Accessories

Order no.	For measuring instrument	Product description	Product type
4102220	16 EWri-NA	Receiver	i-Stick
4102357	16 EWR-NA	Data Connection Cable USB (2 m)	16 EXu
4102410	16 EWR-NA	Data Connection Cable RS232C (2 m)	16 EXr
4102520	16 EWR-NA, 16 EWri-NA	Battery 3 V, CR 2032	
4102915	16 EWR-NA	Digimatic data cable (2 m)	16 EWd



i-Stick



# Digital Caliper for special applications MarCal 16 EWri-S / 16 EWR-S

## Functions 16 EWri-S:

- ON/OFF
- AUTO-ON / OFF
- mm/inch
- LOCK function (key lock)
- RESET (set display to zero)
- PRESET (for entering a numerical value)
- DATA (Data transmission)
- HOLD (storage of measured values)

## Functions 16 EWR-S:

- ON/OFF
- AUTO-ON / OFF
- mm/inch
- LOCK function (key lock)
- RESET (set display to zero)
- DATA (Data transmission via connection cable)

- High contrast analog display
- Locking screw above
- Lapped guideway
- Measuring blade for inside measurements
- Slide and beam made of hardened stainless steel
- Step measuring function
- Immediate measurements due to the Reference System
- Raised guideways for the protection of the scale
- Excellent resistance against dust, coolants and lubricants
- Dirt wipers are integrated in the slide

## Features 16 EWri-S:

- **Height of digits:** 11 mm
- **Data interface:** Integrated wireless
- **Energy supply:** Battery, life span ca. 3 years
- **IP protection category:** IP 67
- **Scope of delivery:** Battery, Instruction manual, Case

## Features 16 EWR-S:

- **Height of digits:** 8,5 mm
- **Data interface:** USB, Opto RS232C, Digimatic
- **Energy supply:** Battery, life span ca. 3 years
- **IP protection category:** IP 67
- **Scope of delivery:** Battery, Instruction manual, Case



REFERENCE

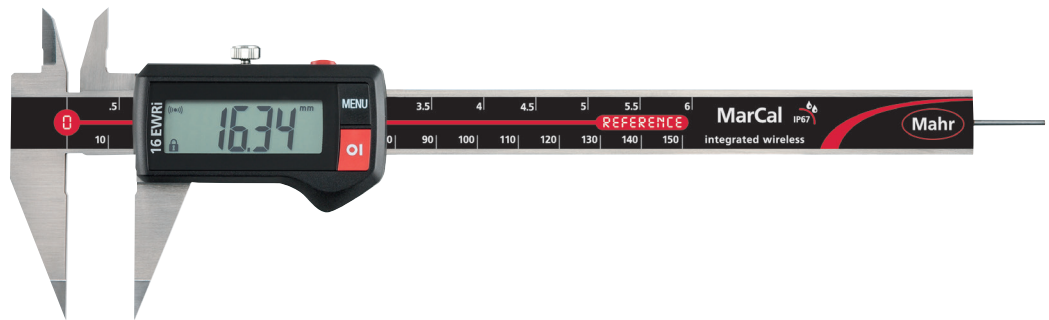

REFERENCE

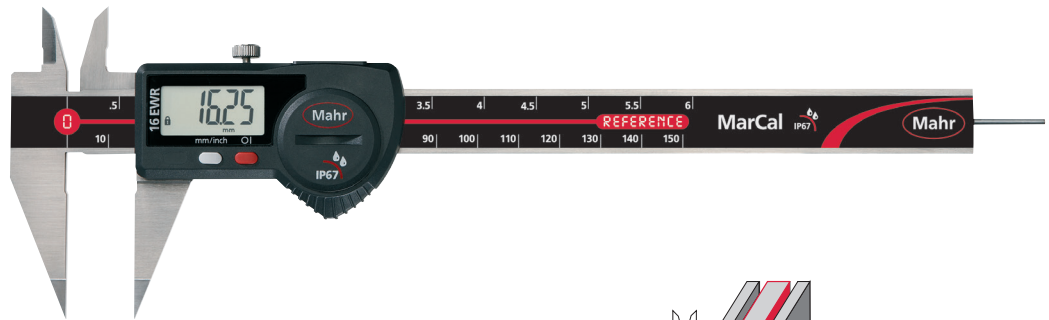

## Application:

With pointed jaws e.g. for measuring distances between grooves

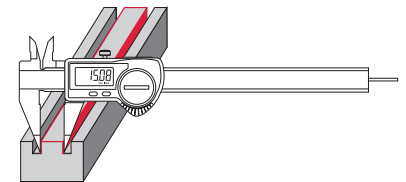

## Technical Data

Order no.	Product type	Measuring range		Resolution	Error limit		Standard	Depth Rod
		mm	inch		mm	inch		
4103375	16 EWri-S	0 – 150	0 – 6"	0,01 / .0005"	0,03	.001"	Factory standard	round
4103075	16 EWR-S	0 – 150	0 – 6"	0,01 / .0005"	0,03	.001"	Factory standard	round

Order no.	a	b	c	d	e
	mm	mm	mm	mm	mm
4103375	10	40	16,5	235	16
4103075	10	40	16,5	235	16

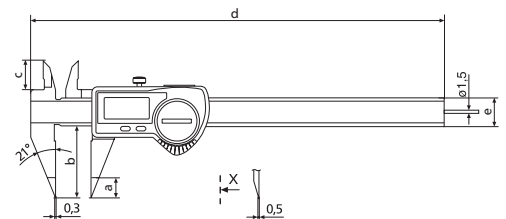

## Accessories

Order no.	For measuring instrument	Product description	Product type
4102220	16 EWri-S	Receiver	i-Stick
4102357	16 EWR-S	Data Connection Cable USB (2 m)	16 EXu
4102410	16 EWR-S	Data Connection Cable RS232C (2 m)	16 EXr
4102520	16 EWR-S, 16 EWri-S	Battery 3 V, CR 2032	
4102915	16 EWR-S	Digimatic data cable (2 m)	16 EWD



i-Stick



# Digital Caliper for special applications MarCal 16 EWri-SM / 16 EWR-SM



REFERENCE

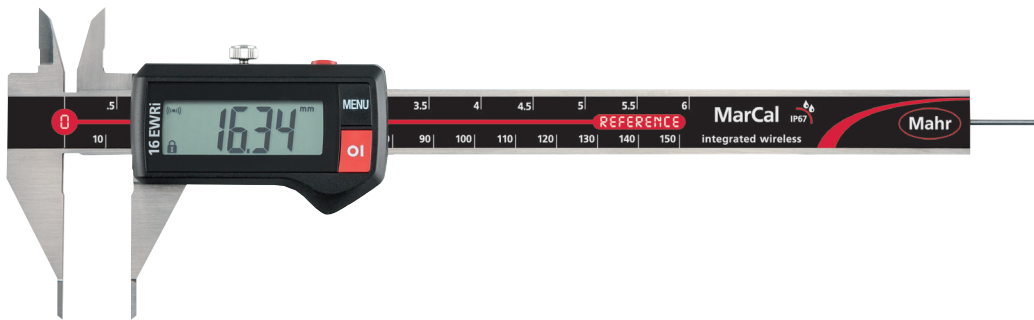

### Functions 16 EWri-SM:

- ON/OFF
- AUTO-ON / OFF
- mm/inch
- LOCK function (key lock)
- RESET (set display to zero)
- PRESET (for entering a numerical value)
- DATA (Data transmission)
- HOLD (storage of measured values)



REFERENCE

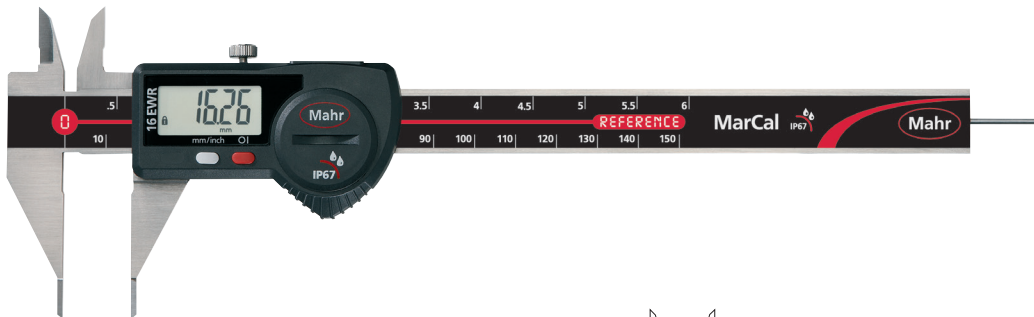

### Functions 16 EWR-SM:

- ON/OFF
- AUTO-ON / OFF
- mm/inch
- LOCK function (key lock)
- RESET (set display to zero)
- DATA (Data transmission via connection cable)

### Application:

With pointed jaws e.g. for measuring distances between grooves

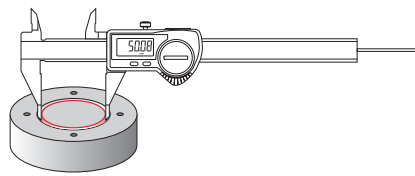

- High contrast analog display
- Locking screw above
- Lapped guideway
- Measuring blade for inside measurements
- Slide and beam made of hardened stainless steel
- Step measuring function
- Immediate measurements due to the Reference System
- Raised guideways for the protection of the scale
- Excellent resistance against dust, coolants and lubricants
- Dirt wipers are integrated in the slide

### Technical Data

Order no.	Product type	Measuring range		Resolution	Error limit		Standard	Depth Rod
		mm	inch		mm	inch		
4103376	16 EWri-SM	0 - 150	0 - 6"	0,01 / .0005"	0,03	.001"	Factory standard	round
4103076	16 EWR-SM	0 - 150	0 - 6"	0,01 / .0005"	0,03	.001"	Factory standard	round

Order no.	a	b	c	d	e
	mm	mm	mm	mm	mm
4103376	10	40	16,5	235	16
4103076	10	40	16,5	235	16

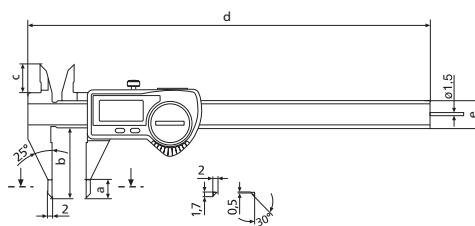

### Features 16 EWri-SM:

- **Height of digits:** 11 mm
- **Data interface:** Integrated wireless
- **Energy supply:** Battery, life span ca. 3 years
- **IP protection category:** IP 67
- **Scope of delivery:** Battery, Instruction manual, Case

### Features 16 EWR-SM:

- **Height of digits:** 8,5 mm
- **Data interface:** USB, Opto RS232C, Digimatic
- **Energy supply:** Battery, life span ca. 3 years
- **IP protection category:** IP 67
- **Scope of delivery:** Battery, Instruction manual, Case

### Accessories

Order no.	For measuring instrument	Product description	Product type
4102220	16 EWri-SM	Receiver	i-Stick
4102357	16 EWR-SM	Data Connection Cable USB (2 m)	16 EXu
4102410	16 EWR-SM	Data Connection Cable RS232C (2 m)	16 EXr
4102520	16 EWR-SM, 16 EWri-SM	Battery 3 V, CR 2032	
4102915	16 EWR-SM	Digimatic data cable (2 m)	16 EWd



i-Stick





# Digital Caliper for special applications MarCal 16 EWRI-VS / 16 EWR-VS

## Functions 16 EWRI-VS:

- ON/OFF
- AUTO-ON / OFF
- mm/inch
- LOCK function (key lock)
- RESET (set display to zero)
- PRESET (for entering a numerical value)
- DATA (Data transmission)
- HOLD (storage of measured values)

## Functions 16 EWR-VS:

- ON/OFF
- AUTO-ON / OFF
- mm/inch
- LOCK function (key lock)
- RESET (set display to zero)
- DATA (Data transmission via connection cable)

- High contrast analog display
- Locking screw above
- Lapped guideway
- Measuring blade for inside measurements
- Slide and beam made of hardened stainless steel
- Immediate measurements due to the Reference System
- Raised guideways for the protection of the scale
- Excellent resistance against dust, coolants and lubricants
- Dirt wipers are integrated in the slide

## Features 16 EWRI-VS:

- **Height of digits:** 11 mm
- **Data interface:** Integrated wireless
- **Energy supply:** Battery, life span ca. 3 years
- **IP protection category:** IP 67
- **Scope of delivery:** Battery, Instruction manual, Case

## Features 16 EWR-VS:

- **Height of digits:** 8,5 mm
- **Data interface:** USB, Opto RS232C, Digimatic
- **Energy supply:** Battery, life span ca. 3 years
- **IP protection category:** IP 67
- **Scope of delivery:** Battery, Instruction manual, Case

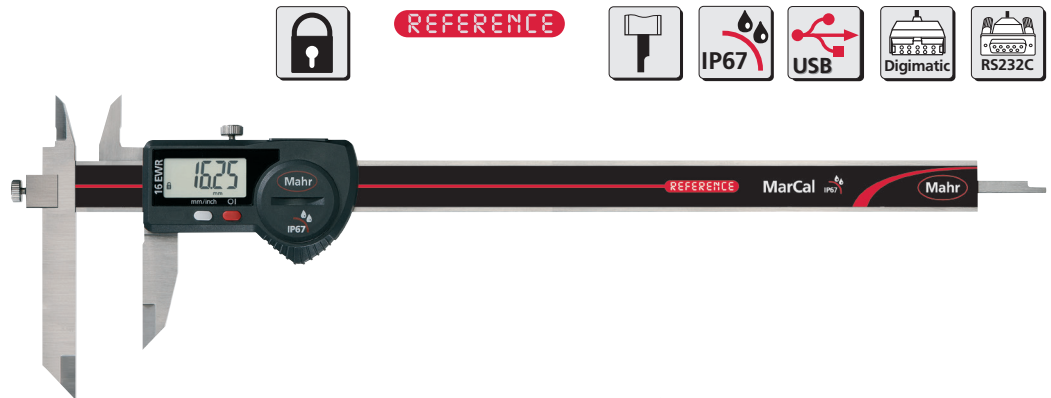

## Application:

With moving jaws for measuring stepped workpieces

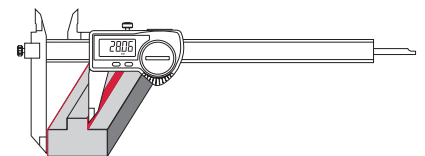

## Technical Data

Order no.	Product type	Measuring range		Resolution	Error limit		Standard	Depth Rod
		mm	inch		mm	inch		
4103383	16 EWRI-VS	0-200	0-8"	0,01 / .0005"	0,04	.0015"	Factory standard	rectangular
4103083	16 EWR-VS	0-200	0-8"	0,01 / .0005"	0,04	.0015"	Factory standard	rectangular

Order no.	a	c	d	e
	mm	mm	mm	mm
4103383	14	18	278	16
4103083	14	18	278	16

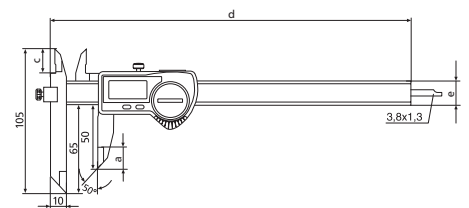

## Accessories

Order no.	For measuring instrument	Product description	Product type
4102220	16 EWRI-VS	Receiver	i-Stick
4102357	16 EWR-VS	Data Connection Cable USB (2 m)	16 EXu
4102410	16 EWR-VS	Data Connection Cable RS232C (2 m)	16 EXr
4102520	16 EWR-VS, 16 EWRI-VS	Battery 3 V, CR 2032	
4102915	16 EWR-VS	Digimatic data cable (2 m)	16 EWD



i-Stick



# Digital Caliper for special applications MarCal 16 EWri-BA / 16 EWR-BA



### Functions 16 EWri-BA:

- ON/OFF
- AUTO-ON / OFF
- mm/inch
- LOCK function (key lock)
- RESET (set display to zero)
- PRESET (for entering a numerical value)
- DATA (Data transmission)
- HOLD (storage of measured values)



### Functions 16 EWR-BA:

- ON/OFF
- AUTO-ON / OFF
- mm/inch
- LOCK function (key lock)
- RESET (set display to zero)
- PRESET (for entering a numerical value)
- DATA (Data transmission via connection cable)

### Application:

For measuring the distance between bores

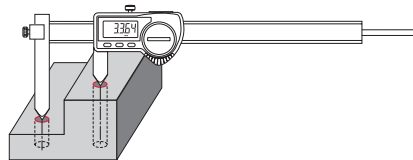

- High contrast analog display
- Locking screw above
- Lapped guideway
- Slide and beam made of hardened stainless steel
- Immediate measurements due to the Reference System
- Raised guideways for the protection of the scale
- Excellent resistance against dust, coolants and lubricants
- Dirt wipers are integrated in the slide

### Technical Data

Order no.	Product type	Measuring range		Resolution	Error limit		Standard	Depth Rod
		mm	inch		mm/inch	mm		
4103384	16 EWri-BA	10 – 210	0,4 – 8,3"	0,01 / .0005"	0,04	.0015"	Factory standard	rectangular
4103084	16 EWR-BA	10 – 210	0,4 – 8,3"	0,01 / .0005"	0,04	.0015"	Factory standard	rectangular

Order no.	d		e
	mm	mm	
4103384	278	16	
4103084	278	16	

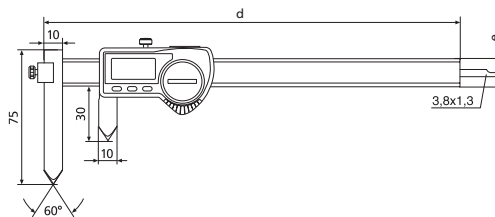

### Features 16 EWri-BA:

- **Height of digits:** 11 mm
- **Data interface:** Integrated wireless
- **Energy supply:** Battery, life span ca. 3 years
- **IP protection category:** IP 67
- **Scope of delivery:** Battery, Instruction manual, Case

### Features 16 EWR-BA:

- **Height of digits:** 8,5 mm
- **Data interface:** USB, Opto RS232C, Digimatic
- **Energy supply:** Battery, life span ca. 3 years
- **IP protection category:** IP 67
- **Scope of delivery:** Battery, Instruction manual, Case

### Accessories

Order no.	For measuring instrument	Product description	Product type
4102220	16 EWri-BA	Receiver	i-Stick
4102357	16 EWR-BA	Data Connection Cable USB (2 m)	16 EXu
4102410	16 EWR-BA	Data Connection Cable RS232C (2 m)	16 EXr
4102520	16 EWR-BA, 16 EWri-BA	Battery 3 V, CR 2032	
4102915	16 EWR-BA	Digimatic data cable (2 m)	16 EWd



i-Stick



# Digital Caliper for special applications MarCal 16 EWRI-SA / 16 EWR-SA

## Functions 16 EWRI-SA:

- ON/OFF
- AUTO-ON / OFF
- mm/inch
- LOCK function (key lock)
- RESET (set display to zero)
- PRESET (for entering a numerical value)
- DATA (Data transmission)
- HOLD (storage of measured values)

## Functions 16 EWR-SA:

- ON/OFF
- AUTO-ON / OFF
- mm/inch
- LOCK function (key lock)
- RESET (set display to zero)
- DATA (Data transmission via connection cable)

- High contrast analog display
- Locking screw above
- Lapped guideway
- Slide and beam made of hardened stainless steel
- Immediate measurements due to the Reference System
- Raised guideways for the protection of the scale
- Excellent resistance against dust, coolants and lubricants
- Dirt wipers are integrated in the slide

## Features 16 EWRI-SA:

- **Height of digits:** 11 mm
- **Data interface:** Integrated wireless
- **Energy supply:** Battery, life span ca. 3 years
- **IP protection category:** IP 67
- **Scope of delivery:** Battery, Instruction manual, Case

## Features 16 EWR-SA:

- **Height of digits:** 8,5 mm
- **Data interface:** USB, Opto RS232C, Digimatic
- **Energy supply:** Battery, life span ca. 3 years
- **IP protection category:** IP 67
- **Scope of delivery:** Battery, Instruction manual, Case



REFERENCE



REFERENCE



## Application:

Inward-angled measuring tips for measuring wall thicknesses and recesses on shafts

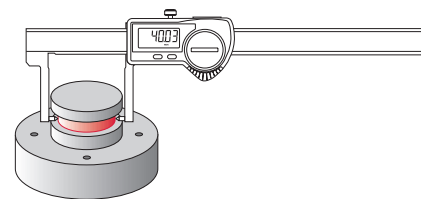

## Technical Data

Order no.	Product type	Measuring range		Resolution	Error limit		Standard	Depth Rod
		mm	inch		mm	inch		
4103377	16 EWRI-SA	0-140	0-6"	0,01 / .0005"	0,03	.001"	Factory standard	none
4103077	16 EWR-SA	0-140	0-6"	0,01 / .0005"	0,03	.001"	Factory standard	none

Order no.	b	d	e
	mm	mm	mm
4103377	40	235	16
4103077	40	235	16

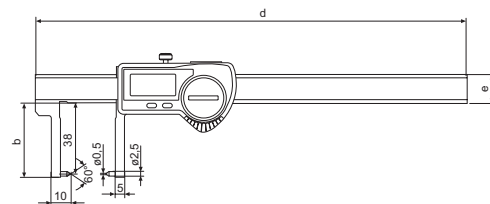

## Accessories

Order no.	For measuring instrument	Product name	Product type
4102220	16 EWRI-SA	Receiver	i-Stick
4102357	16 EWR-SA	16 EXu Data connection cable USB (2 m)	16 EXu
4102410	16 EWR-SA	Data connection cable RS232C (2 m)	16 EXr
4102520	16 EWRI-SA, 16 EWR-SA	Battery 3 V, CR 2032	
4102915	16 EWR-SA	Digimatic data cable (2 m)	16 EWd



i-Stick



# Digital Caliper for special applications MarCal 16 EWri-AA / 16 EWR-AA

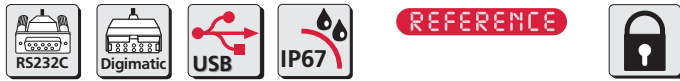

## Functions 16 EWri-AA:

- ON/OFF
- AUTO-ON / OFF
- mm/inch
- LOCK function (key lock)
- RESET (set display to zero)
- PRESET (for entering a numerical value)
- DATA (Data transmission)
- HOLD (storage of measured values)

## Functions 16 EWR-AA:

- ON/OFF
- AUTO-ON / OFF
- mm/inch
- LOCK function (key lock)
- RESET (set display to zero)
- DATA (Data transmission via connection cable)

## Application:

Inward-angled measuring surfaces for measuring wall thicknesses and recesses on shafts

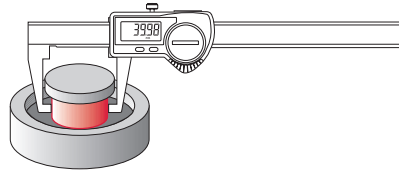

- High contrast analog display
- Locking screw above
- Lapped guideway
- Slide and beam made of hardened stainless steel
- Immediate measurements due to the Reference System
- Raised guideways for the protection of the scale
- Excellent resistance against dust, coolants and lubricants
- Dirt wipers are integrated in the slide

## Technical Data

Order no.	Product type	Measuring range		Resolution	Error limit		Standard	Depth Rod
		mm	inch		mm	inch		
4103379	16 EWri-AA	0 - 150	0 - 6"	0,01 / .0005"	0,03	.001"	Factory standard	none
4103079	16 EWR-AA	0 - 150	0 - 6"	0,01 / .0005"	0,03	.001"	Factory standard	none

Order no.	b	d	e
	mm	mm	mm
4103379	40	235	16
4103079	40	235	16

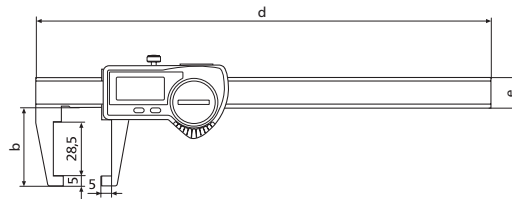

## Features 16 EWri-AA:

- **Height of digits:** 11 mm
- **Data interface:** Integrated wireless
- **Energy supply:** Battery, life span ca. 3 years
- **IP protection category:** IP 67
- **Scope of delivery:** Battery, Instruction manual, Case

## Features 16 EWR-AA:

- **Height of digits:** 8,5 mm
- **Data interface:** USB, Opto RS232C, Digimatic
- **Energy supply:** Battery, life span ca. 3 years
- **IP protection category:** IP 67
- **Scope of delivery:** Battery, Instruction manual, Case

## Accessories

Order no.	For measuring instrument	Product description	Product type
4102220	16 EWri-AA	Receiver	i-Stick
4102357	16 EWR-AA	Data Connection Cable USB (2 m)	16 EXu
4102410	16 EWR-AA	Data Connection Cable RS232C (2 m)	16 EXr
4102520	16 EWR-AA, 16 EWri-AA	Battery 3 V, CR 2032	
4102915	16 EWR-AA	Digimatic data cable (2 m)	16 EWd



i-Stick



# Digital Caliper for special applications MarCal 16 EWri-SI / 16 EWR-SI

## Functions 16 EWri-SI:

- ON/OFF
- AUTO-ON / OFF
- mm/inch
- LOCK function (key lock)
- RESET (set display to zero)
- PRESET (for entering a numerical value)
- DATA (Data transmission)
- HOLD (storage of measured values)

## Functions 16 EWR-SI:

- ON/OFF
- AUTO-ON / OFF
- mm/inch
- LOCK function (key lock)
- RESET (set display to zero)
- PRESET (for entering a numerical value)
- DATA (Data transmission via connection cable)

- High contrast analog display
- Locking screw above
- Lapped guideway
- Slide and beam made of hardened stainless steel
- Immediate measurements due to the Reference System
- Raised guideways for the protection of the scale
- Excellent resistance against dust, coolants and lubricants
- Dirt wipers are integrated in the slide

## Features 16 EWri-SI:

- **Height of digits:** 11 mm
- **Data interface:** Integrated wireless
- **Energy supply:** Battery, life span ca. 3 years
- **IP protection category:** IP 67
- **Scope of delivery:** Battery, Instruction manual, Case

## Features 16 EWR-SI:

- **Height of digits:** 8,5 mm
- **Data interface:** USB, Opto RS232C, Digimatic
- **Energy supply:** Battery, life span ca. 3 years
- **IP protection category:** IP 67
- **Scope of delivery:** Battery, Instruction manual, Case



REFERENCE



REFERENCE



## Application:

Outward-angled measuring tips for measuring recesses in bores

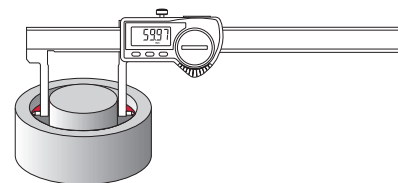

## Technical Data

Order no.	Product type	Measuring range		Resolution	Error limit		Standard	Depth Rod
		mm	inch		mm	inch		
4103378	16 EWri-SI	20 - 170	0,8 - 6,7"	0,01 / .0005"	0,03	.001"	Factory standard	none
4103078	16 EWR-SI	20 - 170	0,8 - 6,7"	0,01 / .0005"	0,03	.001"	Factory standard	none

Order no.	b	d	e
	mm	mm	mm
4103378	38	235	16
4103078	38	235	16

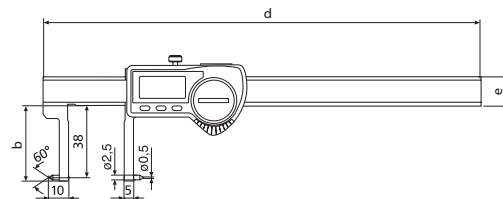

## Accessories

Order no.	For measuring instrument	Product description	Product type
4102220	16 EWri-SI	Receiver	i-Stick
4102357	16 EWR-SI	Data Connection Cable USB (2 m)	16 EXu
4102410	16 EWR-SI	Data Connection Cable RS232C (2 m)	16 EXr
4102520	16 EWR-SI, 16 EWri-SI	Battery 3 V, CR 2032	
4102915	16 EWR-SI	Digimatic data cable (2 m)	16 EWd



i-Stick





# Digital Caliper for special applications MarCal 16 EWri-AI / 16 EWR-AI



## Application:

Outward-angled measuring surfaces for measuring recesses in bores

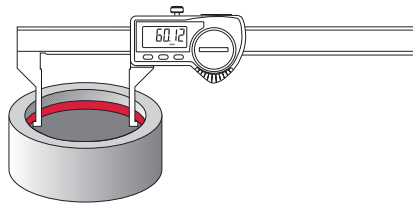

## Technical Data

Order no.	Product type	Measuring range		Resolution	Error limit		Standard	Depth Rod
		mm	inch		mm/inch	mm		
4103380	16 EWri-AI	10 – 160	0,4 – 6,3"	0,01 / .0005"	0,03	.001"	Factory standard	none
4103080	16 EWR-AI	10 – 160	0,4 – 6,3"	0,01 / .0005"	0,03	.001"	Factory standard	none

Order no.	b	d	e
	mm	mm	mm
4103380	40	235	16
4103080	40	235	16

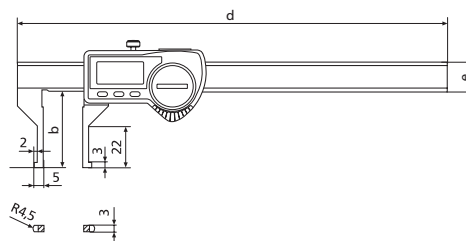

## Functions 16 EWri-AI:

- ON/OFF
- AUTO-ON / OFF
- mm/inch
- LOCK function (key lock)
- RESET (set display to zero)
- PRESET (for entering a numerical value)
- DATA (Data transmission)
- HOLD (storage of measured values)

## Functions 16 EWR-AI:

- ON/OFF
- AUTO-ON / OFF
- mm/inch
- LOCK function (key lock)
- RESET (set display to zero)
- PRESET (for entering a numerical value)
- DATA (Data transmission via connection cable)

- High contrast analog display
- Locking screw above
- Lapped guideway
- Slide and beam made of hardened stainless steel
- Immediate measurements due to the Reference System
- Raised guideways for the protection of the scale
- Excellent resistance against dust, coolants and lubricants
- Dirt wipers are integrated in the slide

## Features 16 EWri-AI:

- **Height of digits:** 11 mm
- **Data interface:** Integrated wireless
- **Energy supply:** Battery, life span ca. 3 years
- **IP protection category:** IP 67
- **Scope of delivery:** Battery, Instruction manual, Case

## Features 16 EWR-AI:

- **Height of digits:** 8,5 mm
- **Data interface:** USB, Opto RS232C, Digimatic
- **Energy supply:** Battery, life span ca. 3 years
- **IP protection category:** IP 67
- **Scope of delivery:** Battery, Instruction manual, Case

## Accessories

Order no.	For measuring instrument	Product description	Product type
4102220	16 EWri-AI	Receiver	i-Stick
4102357	16 EWR-AI	Data Connection Cable USB (2 m)	16 EXu
4102410	16 EWR-AI	Data Connection Cable RS232C (2 m)	16 EXr
4102520	16 EWR-AI, 16 EWri-AI	Battery 3 V, CR 2032	
4102915	16 EWR-AI	Digimatic data cable (2 m)	16 EWd



i-Stick





# Digital Caliper for special applications MarCal 16 EWRI-RW / 16 EWR-RW

## Functions 16 EWRI-RW:

- ON/OFF
- AUTO-ON / OFF
- mm/inch
- LOCK function (key lock)
- RESET (set display to zero)
- PRESET (for entering a numerical value)
- DATA (Data transmission)
- HOLD (storage of measured values)

## Functions 16 EWR-RW:

- ON/OFF
- AUTO-ON / OFF
- mm/inch
- LOCK function (key lock)
- RESET (set display to zero)
- DATA (Data transmission via connection cable)

- High contrast analog display
- Locking screw above
- Lapped guideway
- Slide and beam made of hardened stainless steel
- Immediate measurements due to the Reference System
- Raised guideways for the protection of the scale
- Excellent resistance against dust, coolants and lubricants
- Dirt wipers are integrated in the slide

## Features 16 EWRI-RW:

- **Height of digits:** 11 mm
- **Data interface:** Integrated wireless
- **Energy supply:** Battery, life span ca. 3 years
- **IP protection category:** IP 67
- **Scope of delivery:** Battery, Instruction manual, Case

## Features 16 EWR-RW:

- **Height of digits:** 8,5 mm
- **Data interface:** USB, Opto RS232C, Digimatic
- **Energy supply:** Battery, life span ca. 3 years
- **IP protection category:** IP 67
- **Scope of delivery:** Battery, Instruction manual, Case



## Application:

Measurement of wall thicknesses

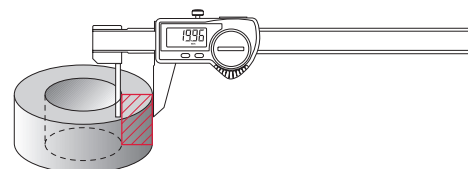

## Technical Data

Order no.	Product type	Measuring range		Resolution	Error limit		Standard	Depth Rod
		mm	inch		mm	inch		
4103381	16 EWRI-RW	0-150	0-6"	0,01 / .0005"	0,05	.002"	Factory standard	none
4103081	16 EWR-RW	0-150	0-6"	0,01 / .0005"	0,05	.002"	Factory standard	none

Order no.	b	d	e
	mm	mm	mm
4103381	40	235	16
4103081	40	235	16

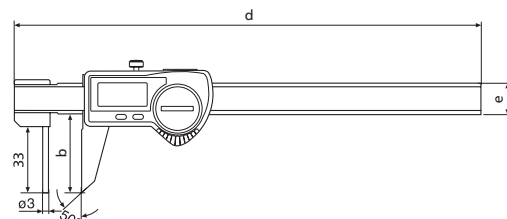

## Accessories

Order no.	For measuring instrument	Product description	Product type
4102220	16 EWRI-RW	Receiver	i-Stick
4102357	16 EWR-RW	Data Connection Cable USB (2 m)	16 EXu
4102410	16 EWR-RW	Data Connection Cable RS232C (2 m)	16 EXr
4102520	16 EWR-RW, 16 EWRI-RW	Battery 3 V, CR 2032	
4102915	16 EWR-RW	Digimatic data cable (2 m)	16 EWD



i-Stick



# Digital Caliper for special applications MarCal 16 EWri-LI / 16 EWR-LI

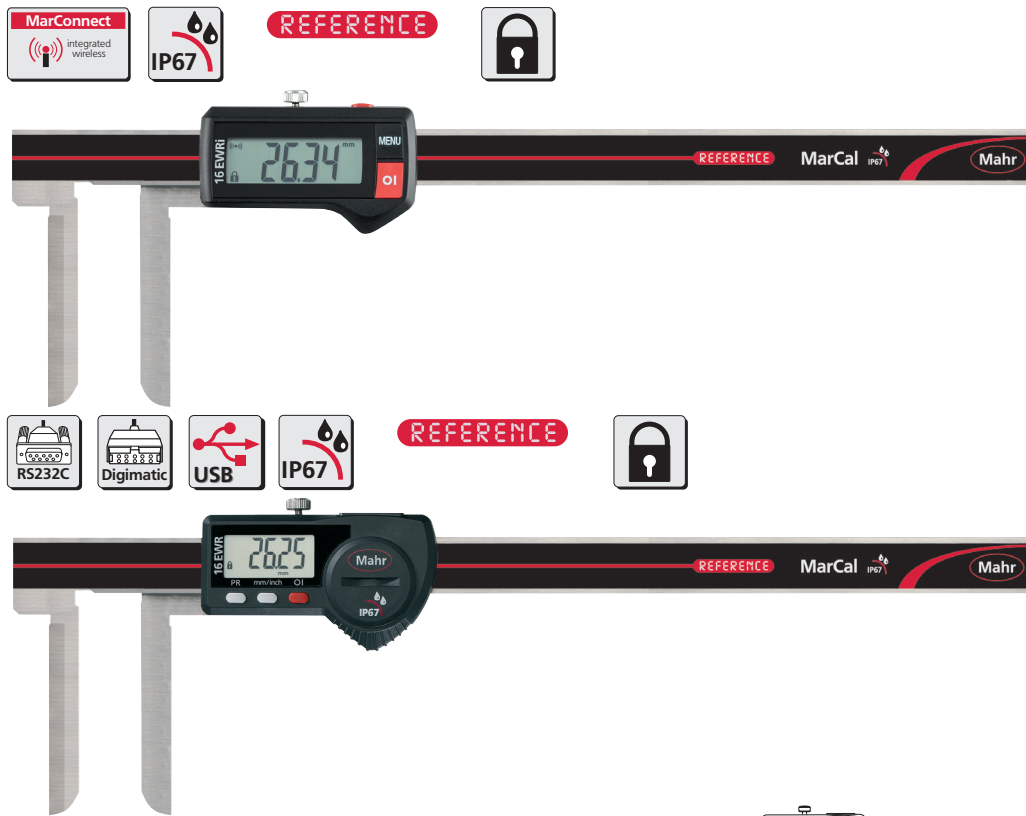

## Application:

With long inner blades

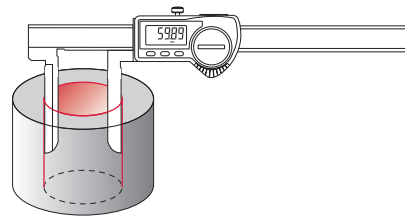

## Technical Data

Order no.	Product type	Measuring range		Resolution	Error limit		Standard	Depth Rod
		mm	inch		mm	inch		
4103385	16 EWri-LI	10 - 200	0,4 - 8"	0,01 / .0005"	0,05	.002"	Factory standard	none
4103085	16 EWR-LI	10 - 200	0,4 - 8"	0,01 / .0005"	0,05	.002"	Factory standard	none

Order no.	b	d	e
	mm	mm	mm
4103385	60	285	16
4103085	60	285	16

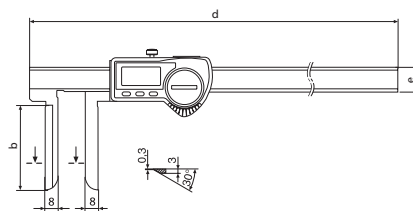

## Accessories

Order no.	For measuring instrument	Product description	Product type
4102220	16 EWri-LI	Receiver	i-Stick
4102357	16 EWR-LI	Data Connection Cable USB (2 m)	16 EXu
4102410	16 EWR-LI	Data Connection Cable RS232C (2 m)	16 EXr
4102520	16 EWR-LI, 16 EWri-LI	Battery 3 V, CR 2032	
4102915	16 EWR-LI	Digimatic data cable (2 m)	16 EWd



i-Stick

## Functions 16 EWri-LI:

- ON/OFF
- AUTO-ON / OFF
- mm/inch
- LOCK function (key lock)
- RESET (set display to zero)
- PRESET (for entering a numerical value)
- DATA (Data transmission)
- HOLD (storage of measured values)

## Functions 16 EWR-LI:

- ON/OFF
- AUTO-ON / OFF
- mm/inch
- LOCK function (key lock)
- RESET (set display to zero)
- PRESET (for entering a numerical value)
- DATA (Data transmission via connection cable)

- High contrast analog display
- Locking screw above
- Lapped guideway
- Measuring blade for inside measurements
- Slide and beam made of hardened stainless steel
- Immediate measurements due to the Reference System
- Raised guideways for the protection of the scale
- Excellent resistance against dust, coolants and lubricants
- Dirt wipers are integrated in the slide
- **Software:** MarCom Professional free download: [www.mahr.com/marcom](http://www.mahr.com/marcom) (only for Mahr data cables and wireless systems with USB and RS232 interface)

## Features 16 EWri-LI:

- **Height of digits:** 11 mm
- **Data interface:** Integrated wireless
- **Energy supply:** Battery, life span ca. 3 years
- **IP protection category:** IP 67
- **Scope of delivery:** Battery, Instruction manual, Case

## Features 16 EWR-LI:

- **Height of digits:** 8,5 mm
- **Data interface:** USB, Opto RS232C, Digimatic
- **Energy supply:** Battery, life span ca. 3 years
- **IP protection category:** IP 67
- **Scope of delivery:** Battery, Instruction manual, Case



# Digital workshop caliper MarCal 18 EWR

## Functions:

- AUTO-ON / OFF
- DATA (Data transmission via connection cable)
- ON/OFF
- PRESET (for entering a numerical value)
- RESET (set display to zero)
- mm/inch
- LOCK function (key lock)
- Measuring blades for outside measurements
- High contrast analog display
- Locking screw above
- Rounded measuring blades for inside measurements
- Slide and beam made of hardened stainless steel
- Immediate measurements due to the Reference System
- Raised guideways for the protection of the scale
- Excellent resistance against dust, coolants and lubricants
- Dirt wipers are integrated in the slide
- **Software:** MarCom Professional free download:  
[www.mahr.com/marcom](http://www.mahr.com/marcom) (only for Mahr data cables and wireless systems with USB and RS232 interface)
- **Digit height:** 10 mm (300mm), 12,5 mm
- **Data interface:** USB, Opto RS232C, Digimatic, Wireless
- **Energy supply:** Battery life approx. 3 years
- **IP protection category:** IP 65
- **Scope of delivery:** Battery, Instruction manual, Case

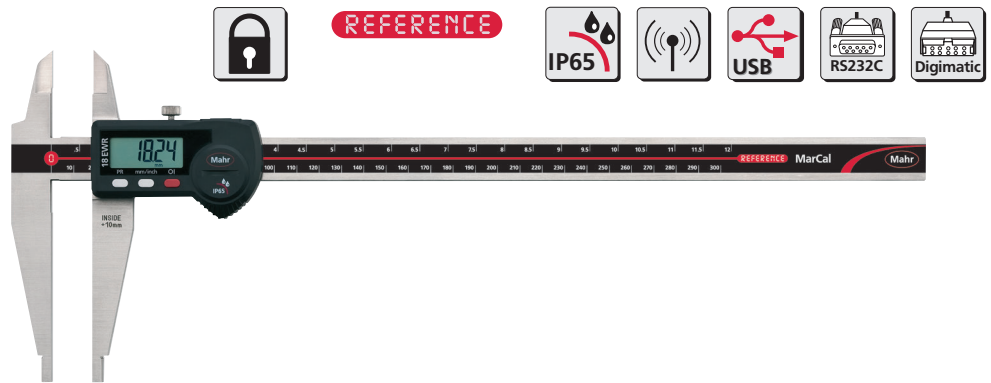

## Technical Data

Order no.	Product type	Measuring range		Resolution	Error limit		Standard	Weight
		mm	inch		mm	inch		
4112704	18 EWR	0 – 300	0 – 12"	0,01 / .0005"	0,03	.001"	Factory standard	0,45
4112712	18 EWR	0 – 500	0 – 20"	0,01 / .0005"	0,04	.0015"	Factory standard	1,10
4112714	18 EWR	0 – 750	0 – 30"	0,01 / .0005"	0,05	.002"	Factory standard	1,35
4112716	18 EWR	0 – 1000	0 – 40"	0,01 / .0005"	0,06	.0025"	Factory standard	2,20

Order no.	a	b	c	d	e	f
	mm	mm	mm	mm	mm	mm
4112704	410	90	10	10	20	40
4112712	650	150	20	20	25	55
4112714	905	150	20	20	25	55
4112716	1165	150	20	20	30	60

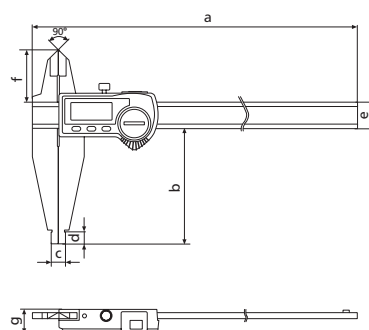

## Accessories

Order no.	Product description	Product type
4102230	Receiver	e-Stick
4102231	Transmitter for e-Stick	16 EWe
4102357	Data Connection Cable USB (2 m)	16 EXu
4102410	Data Connection Cable RS232C (2 m)	16 EXr
4102520	Battery 3 V, CR 2032	
4102915	Digimatic data cable (2 m)	16 EWd



16 EWe



e-Stick



# Digital workshop caliper MarCal 18 EWR



- Functions:**
- AUTO-ON / OFF
  - DATA (Data transmission via connection cable)
  - ON/OFF
  - PRESET (for entering a numerical value)
  - RESET (set display to zero)
  - mm/inch
  - LOCK function (key lock)

- High contrast analog display
- Locking screw above
- Rounded measuring blades for inside measurements
- Slide and beam made of hardened stainless steel
- Immediate measurements due to the Reference System
- Raised guideways for the protection of the scale
- Excellent resistance against dust, coolants and lubricants
- Dirt wipers are integrated in the slide

- **Software:** MarCom Professional free download: [www.mahr.com/marcom](http://www.mahr.com/marcom) (only for Mahr data cables and wireless systems with USB and RS232 interface)

- **Digit height:** 10 mm (300mm), 12,5 mm

- **Data interface:** USB, Opto RS232C, Digimatic, Wireless

- **Energy supply:** Battery life approx. 3 years

- **IP protection category:** IP 65

- **Scope of delivery:** Battery, Instruction manual, Case

## Technical Data

Order no.	Product type	Measuring range		Resolution	Error limit		Standard	Weight
		mm	inch		mm/inch	mm		
4112705	18 EWR	0-300	0-12"	0,01 / .0005"	0,03	.001"	Factory standard	0,44
4112713	18 EWR	0-500	0-20"	0,01 / .0005"	0,04	.0015"	Factory standard	1,00
4112715	18 EWR	0-750	0-30"	0,01 / .0005"	0,05	.002"	Factory standard	1,28
4112717	18 EWR	0-1000	0-40"	0,01 / .0005"	0,06	.0025"	Factory standard	2,10

Order no.	a	b	c	d	e
	mm	mm	mm	mm	mm
4112705	410	90	10	10	20
4112713	650	150	20	20	25
4112715	905	150	20	20	25
4112717	1165	150	20	20	30

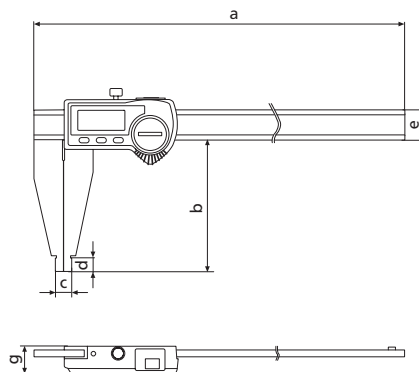

## Accessories

Order no.	Product description	Product type
4102230	Receiver	e-Stick
4102231	Transmitter for e-Stick	16 EWe
4102357	Data Connection Cable USB (2 m)	16 EXu
4102410	Data Connection Cable RS232C (2 m)	16 EXr
4102520	Battery 3 V, CR 2032	
4102915	Digimatic data cable (2 m)	16 EWd

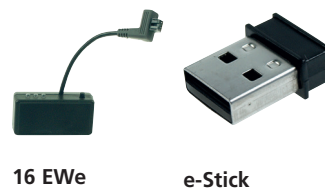



# Digital workshop caliper MarCal 18 ESA

## Functions:

- ON/OFF
- RESET (set display to zero)
- mm/inch
- HOLD (storage of measured values)
- PRESET (enter a numerical value) from range 500 mm
- High contrast analog display
- Locking screw above
- Rounded measuring blades for inside measurements
- Prisma guide ways for a more smooth and even movement
- Measuring surfaces made of steel
- Measuring blades for outside measurements
- To reduce the overall weight the slide and beam are made from aluminum and are coated with a hard anodized surface coating (1100 HV)
- Dirt wipers are integrated in the slide
- **Software:** MarCom Professional free download: [www.mahr.com/marcom](http://www.mahr.com/marcom) (only for Mahr data cables and wireless systems with USB and RS232 interface)
- **Digit height:** 6 mm (300mm), 10,5 mm
- **Data interface:** Opto RS232C (only 300 mm version)
- **Energy supply:** Battery life approx. 2 years
- **IP protection category:** none
- **Scope of delivery:** Battery, Instruction manual, Case



## Technical Data

Order no.	Product type	Measuring range		Resolution	Error limit		Standard	Weight
		mm	inch		mm	inch		
4112620	18 ESA	0 – 300	0 – 12"	0.01 / .0005"	0.04	.0015"	Factory standard	0.50
4112621	18 ESA	0 – 500	0 – 20"	0.01 / .0005"	0.05	.002"	Factory standard	1.40
4112622	18 ESA	0 – 800	0 – 32"	0.01 / .0005"	0.07	.0025"	Factory standard	1.60
4112623	18 ESA	0 – 1000	0 – 40"	0.01 / .0005"	0.08	.003"	Factory standard	1.80

Order no.	a	b	c	d	e	f	g	h	i
	mm	mm	mm	mm	mm	mm	mm	mm	mm
4112620	450	33	90	17,5	10	10	25	4,5	17
4112621	726	42	150	20,7	15	20	31,9	6	29
4112622	1026	42	150	20,7	15	20	31,9	6	29
4112623	1760	42	150	20,7	15	20	31,9	6	29

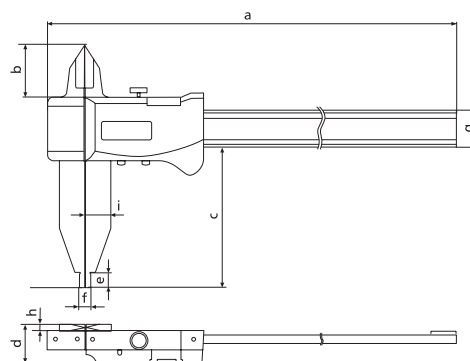

## Accessories

Order no.	Product description	Product type
4102510	Data Connection Cable RS232C (2 m)	16 ESv
4102520	Battery 3 V, CR 2032	



# Workshop Calipers MarCal 18 NA



- To reduce the overall weight the slide and beam are made from aluminum and are coated with a hard anodized surface coating (1100 HV)
- Vernier and main scale have a satin chrome finish for glare free reading
- Parallax free reading
- Locking screw above
- Prisma guide ways for a more smooth and even movement
- Measuring surfaces made of steel
- Measuring blades for outside measurements
- **Scope of delivery:** up to 1000 mm delivered with a case, over 1000 mm individually packed

## Technical Data

Order no.	Product type	Measuring range	Readings	Error limit	Standard	Weight
		mm	mm	mm		kg
4112300	18 NA	0 – 300	0,02	0,04	Factory standard	0,50
4112301	18 NA	0 – 500	0,02	0,05	Factory standard	1,40
4112302	18 NA	0 – 800	0,02	0,07	Factory standard	1,60
4112303	18 NA	0 – 1000	0,02	0,08	Factory standard	1,75
4112304	18 NA	0 – 1500	0,02	0,16	Factory standard	2,10
4112305	18 NA	0 – 2000	0,02	0,16	Factory standard	2,50

Order no.	a	b	c	d	e	f	g	h	i
	mm	mm	mm	mm	mm	mm	mm	mm	mm
4112300	450	33	90	17,5	10	10	25	4,5	17
4112301	726	42	150	20,7	15	20	31,9	6	29
4112302	1026	42	150	20,7	15	20	31,9	6	29
4112303	1226	42	150	20,7	15	20	31,9	6	29
4112304	1760	85	200	25	15	30	48,1	6	40
4112305	2260	85	200	25	15	30	48,1	6	40

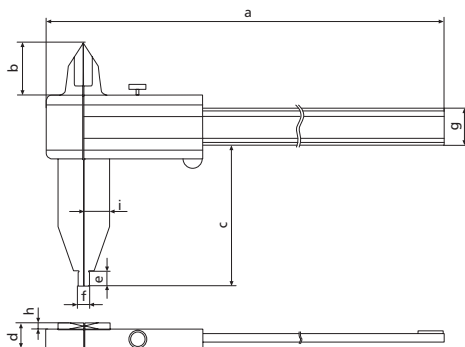





# Workshop Calipers MarCal 18 N

- Measuring blades for outside measurements
- High contrast analog display
- Locking screw above
- Rounded measuring blades for inside measurements
- Slide and beam made of hardened stainless steel
- Immediate measurements due to the Reference System
- Raised guideways for the protection of the scale
- Excellent resistance against dust, coolants and lubricants
- Dirt wipers are integrated in the slide
- **Scope of delivery:** up to 1000 mm delivered with a case, over 1000 mm individually packed

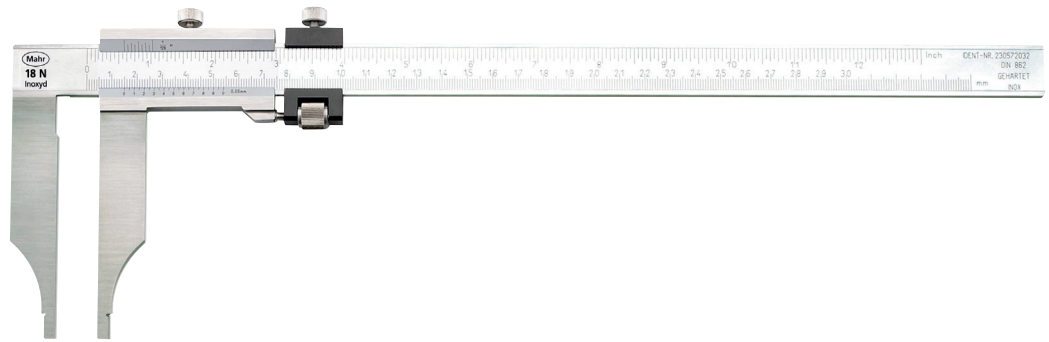

## Technical Data

Order no.	Product type	Measuring range		Vernier value		Error limit		Standard
		mm	inch	mm	inch	mm	inch	
4112220	18 N	0-300		0.02		0.05		Factory standard
4112221	18 N	0-500		0.02		0.06		Factory standard
4112222	18 N	0-800		0.02		0.08		Factory standard
4112223	18 N	0-1000		0.02		0.08		Factory standard
4112224	18 N	0-1500		0.02		0.1		Factory standard
4112225	18 N	0-2000		0.02		0.12		Factory standard
4112230	18 N	0-300	0-12"	0.02	.001"	0.05	.002"	Factory standard
4112231	18 N	0-500	0-20"	0.02	.001"	0.06	.0025"	Factory standard
4112232	18 N	0-800	0-32"	0.02	.001"	0.08	.003"	Factory standard
4112233	18 N	0-1000	0-40"	0.02	.001"	0.08	.003"	Factory standard
4112234	18 N	0-1500	0-60"	0.02	.001"	0.1	.004"	Factory standard
4112235	18 N	0-2000	0-80"	0.02	.001"	0.12	.005"	Factory standard

Order no.	a	b	c	e	f
	mm	mm	mm	mm	mm
4112220	5	10	90	410	20
4112221	10	19	150	675	25
4112222	10	19	150	985	30
4112223	10	19	150	1185	30
4112224	15	19	200	1760	40
4112225	15	19	200	2270	45
4112230	5	10	90	410	20
4112231	10	19	150	675	25
4112232	10	19	150	985	30
4112233	10	19	150	1185	30
4112234	15	19	200	1760	40
4112235	15	19	200	2270	45

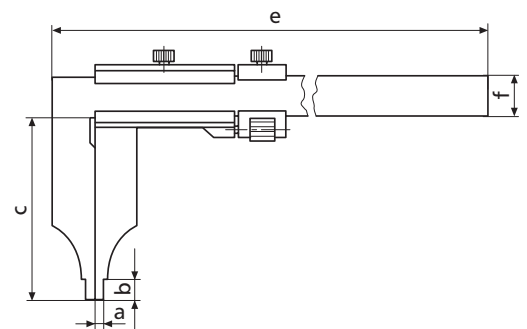



# Workshop Calipers MarCal 18 N

DIN 862



- Vernier and main scale have a satin chrome finish for glare free reading
- Locking screw above
- Rounded measuring blades for inside measurements
- Measuring surfaces made of steel
- Slide and beam made of hardened stainless steel
- Raised guideways for the protection of the scale
- **Scope of delivery:** up to 1000 mm delivered with a case, over 1000 mm individually packed

## Technical Data

Order no.	Product type	Measuring range	Readings	Error limit	Standard
		mm	mm	mm	
4112200	18 N	0 – 200	0,02	0,05	Factory standard
4112201	18 N	0 – 300	0,02	0,05	Factory standard
4112210	18 N	0 – 500	0,05	0,07	DIN 862
4112211	18 N	0 – 800	0,05	0,1	DIN 862
4112212	18 N	0 – 1000	0,05	0,12	DIN 862
4112213	18 N	0 – 1500	0,05	0,18	DIN 862
4112214	18 N	0 – 2000	0,05	0,22	DIN 862

Order no.	a	b	c	e	f
	mm	mm	mm	mm	mm
4112200	5	10	80	310	20
4112201	5	10	90	410	20
4112210	10	19	150	675	25
4112211	10	19	150	985	30
4112212	10	19	150	1185	30
4112213	15	19	200	1760	40
4112214	15	19	200	2270	45

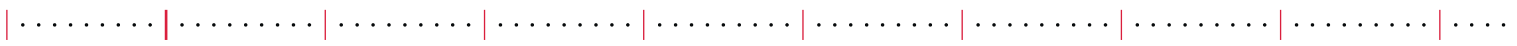
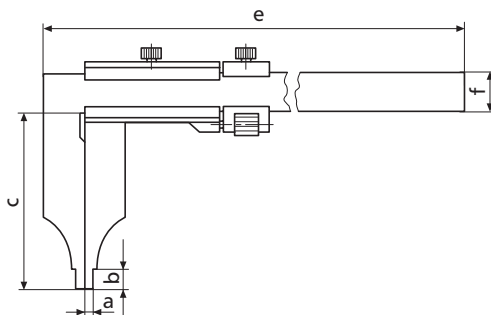



# Workshop Calipers MarCal 18 DN

- With fine adjustment
- Measuring blades for outside measurements
- Vernier and main scale have a satin chrome finish for glare free reading
- Locking screw above
- Rounded measuring blades for inside measurements
- Measuring surfaces made of steel
- Slide and beam made of hardened stainless steel
- Raised guideways for the protection of the scale
- **Scope of delivery:** Case

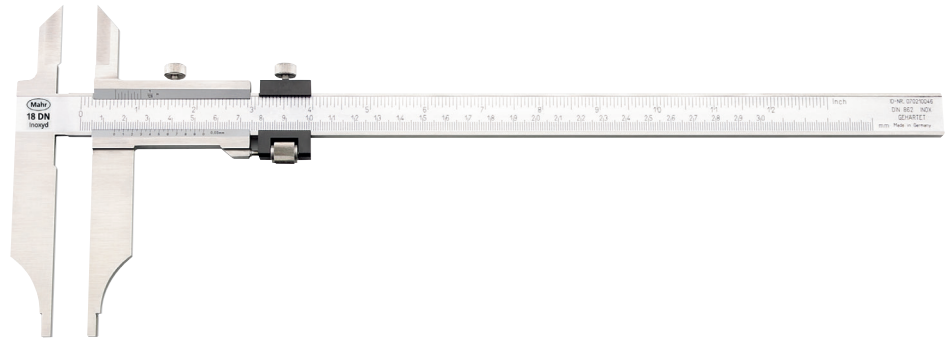

## Technical Data

Order no.	Product type	Measuring range	Readings	Error limit	Standard
		mm	mm	mm	
4113300	18 DN	0 – 200	0,02	0,05	Factory standard
4113301	18 DN	0 – 300	0,02	0,05	Factory standard
4113302	18 DN	0 – 500	0,02	0,06	Factory standard
4113303	18 DN	0 – 800	0,02	0,08	Factory standard
4113304	18 DN	0 – 1000	0,02	0,08	Factory standard

Order no.	a	b	c	d	e	f
	mm	mm	mm	mm	mm	mm
4113300	5	10	80	40	310	20
4113301	5	10	90	40	410	20
4113302	10	19	150	60	675	25
4113303	10	19	150	65	985	30
4113304	10	19	150	67	1185	30

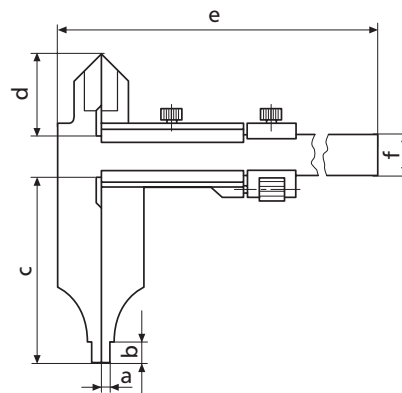



# Workshop Calipers MarCal 18 DN

DIN 862

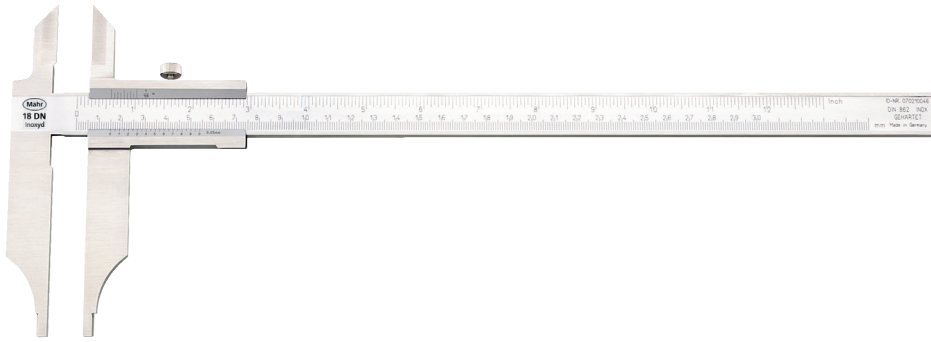

- Measuring blades for outside measurements
- Vernier and main scale have a satin chrome finish for glare free reading
- Locking screw above
- Rounded measuring blades for inside measurements
- Measuring surfaces made of steel
- Slide and beam made of hardened stainless steel
- Raised guideways for the protection of the scale
- **Scope of delivery:** up to 1000 mm delivered with a case, over 1000 mm individually packed

## Technical Data

Order no.	Product type	Measuring range	Readings		Error limit	Standard
			mm	mm		
4113200	18 DN	0 – 200		0,05	0,05	DIN 862
4113201	18 DN	0 – 300		0,05	0,05	DIN 862
4113202	18 DN	0 – 500		0,05	0,07	DIN 862
4113203	18 DN	0 – 800		0,05	0,1	DIN 862
4113204	18 DN	0 – 1000		0,05	0,12	DIN 862
4113205	18 DN	0 – 1500		0,05	0,18	DIN 862
4113206	18 DN	0 – 2000		0,05	0,22	DIN 862

Order no.	a	b	c	d	e	f
	mm	mm	mm	mm	mm	mm
4113200	5	10	80	40	310	20
4113201	5	10	90	40	410	20
4113202	10	19	150	60	675	25
4113203	10	19	150	65	985	30
4113204	10	19	150	67	1185	30
4113205	15	19	200	86	1760	40
4113206	25	19	200	96	2270	45

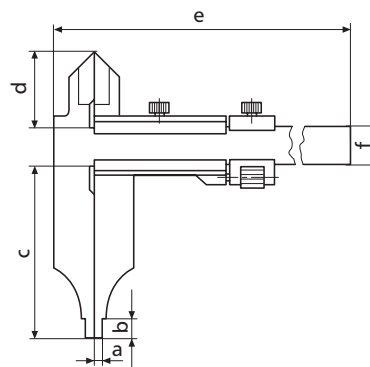



# Digital Depth Gage MarCal 30 EWRI

## Functions:

- ON/OFF
  - AUTO-ON / OFF
  - RESET (set display to zero)
  - mm/inch
  - PRESET (for entering a numerical value)
  - LOCK function (key lock)
  - HOLD (storage of measured values)
  - Reversal of counting direction
  - DATA (data transmission)
- High contrast analog display
  - Locking screw above
  - Lapped guideway
  - Measuring surfaces made of steel
  - Slide and beam made of hardened stainless steel
  - Immediate measurements due to the Reference System
  - Raised guideways for the protection of the scale
  - Excellent resistance against dust, coolants and lubricants
  - Dirt wipers are integrated in the slide
  - **Digit height:** 11 mm
  - **Data interface:** Integrated wireless
  - **Energy supply:** Battery life approx. 3 years (approx. 0,5 in wireless mode)
  - **IP protection category:** IP 67
  - **Scope of delivery:** Battery, Instruction manual, Case



## Technical Data

Order no.	Product type	Measuring range		Resolution	Error limit		Standard
		mm	inch		mm	inch	
4126755	30 EWri	0 – 150	0 – 6"	0,01 / .0005"	0,03	.001"	Factory standard
4126756	30 EWri	0 – 300	0 – 12"	0,01 / .0005"	0,04	.0015"	Factory standard
4126757	30 EWri	0 – 500	0 – 20"	0,01 / .0005"	0,05	.002"	Factory standard

Order no.	a	b
4126755	234 mm	100 mm
4126756	384 mm	150 mm
4126757	584 mm	150 mm

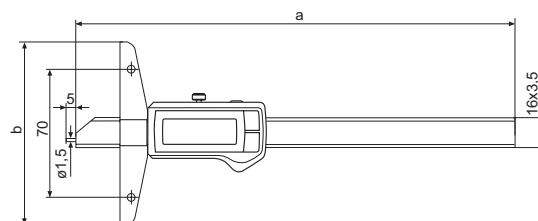

## Accessories

Order no.	Product description	Product type
4102220	Receiver	i-Stick
4102520	Battery 3 V, CR 2032	
4125611	Anvil (4 mm)	30 ESa
4126510	Cross Beam Extension (300 mm)	30 EXm
4126511	Cross Beam Extension (200 mm)	30 EXm



i-Stick

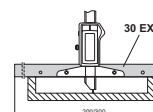

30 EXm

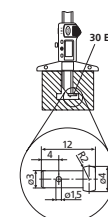

30 ESa



# Digital Depth Gage MarCal 30 EWR



REFERENCE



### Functions:

- AUTO-ON / OFF
- DATA (Data transmission via connection cable)
- ON/OFF
- PRESET (for entering a numerical value)
- RESET (set display to zero)
- mm/inch
- LOCK function (key lock)

- High contrast analog display
- Locking screw above
- Lapped guideway
- Measuring surfaces made of steel
- Slide and beam made of hardened stainless steel
- Immediate measurements due to the Reference System
- Raised guideways for the protection of the scale
- Excellent resistance against dust, coolants and lubricants
- Dirt wipers are integrated in the slide
- **Digit height:** 8,5 mm
- **Data interface:** USB, Opto RS232C, Digimatic
- **IP protection category:** IP 67
- **Scope of delivery:** Battery, Instruction manual, Case

## Technical Data

Order no.	Product type	Measuring range		Resolution	Error limit		Standard
		mm	inch		mm/inch	mm	
4126700	30 EWR	0 – 150	0 – 6"	0,01 / .0005"	0,03	.001"	Factory standard
4126701	30 EWR	0 – 300	0 – 12"	0,01 / .0005"	0,04	.0015"	Factory standard
4126702	30 EWR	0 – 500	0 – 20"	0,01 / .0005"	0,05	.002"	Factory standard

Order no.	a	b
	mm	mm
4126700	234	100
4126701	384	150
4126702	584	150

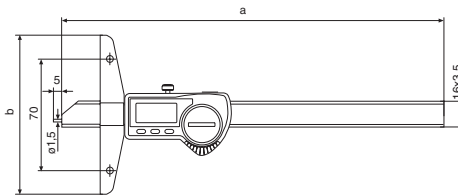

## Accessories

Order no.	Product description	Product type
4102357	Data Connection Cable USB (2 m)	16 EXu
4102410	Data Connection Cable RS232C (2 m)	16 EXr
4102520	Battery 3 V, CR 2032	
4102915	Digimatic data cable (2 m)	16 EWd
4125611	Anvil (4 mm)	30 ESa
4126510	Cross Beam Extension (300 mm)	30 EXm
4126511	Cross Beam Extension (200 mm)	30 EXm

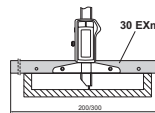

30 EXm

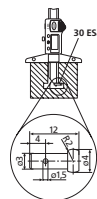

30 ESa





# Digital Depth Gage MarCal 30 EWri-D

## Functions:

- ON/OFF
- AUTO-ON / OFF
- mm/inch
- LOCK function (key lock)
- RESET (set display to zero)
- PRESET (for entering a numerical value)
- DATA (data transmission)
- HOLD (storage of measured values)



REFERENCE



- High contrast analog display
- Locking screw above
- Lapped guideway
- Measuring surfaces made of steel
- Slide and beam made of hardened stainless steel
- Immediate measurements due to the Reference System
- Raised guideways for the protection of the scale
- Excellent resistance against dust, coolants and lubricants
- Dirt wipers are integrated in the slide
- **Digit height:** 11 mm
- **Data interface:** Integrated wireless
- **Energy supply:** Battery life approx. 3 years (approx. 0,5 in wireless mode)
- **IP protection category:** IP 67
- **Scope of delivery:** Battery, Instruction manual, Case

## Application:

Measuring groove widths and distances between grooves

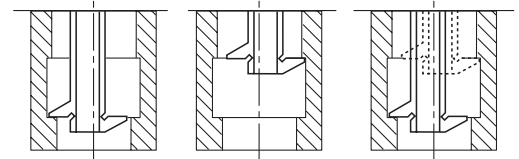

## Technical Data

Order no.	Product type	Measuring range		Resolution	Error limit		Standard
		mm	inch		mm	inch	
4126533	30 EWri-D	0 – 200	0 – 8"	0,01 / .0005"	0,03	.001"	Factory standard
4126534	30 EWri-D	0 – 300	0 – 12"	0,01 / .0005"	0,04	.001"	Factory standard

Order no.	a	b	c
	mm	mm	mm
4126533	281	100	12
4126534	381	150	12

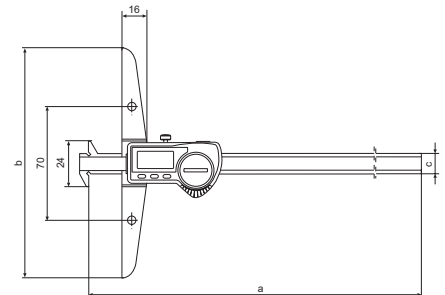

## Accessories

Order no.	Product description	Product type
4102220	Receiver	i-Stick
4102520	Battery 3 V, CR 2032	
4126510	Cross Beam Extension (300 mm)	30 EXm
4126511	Cross Beam Extension (200 mm)	30 EXm



i-Stick

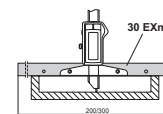

30 EXm



# Digital Depth Gage MarCal 30 EWR-D



## Application:

Measuring groove widths and distances between grooves

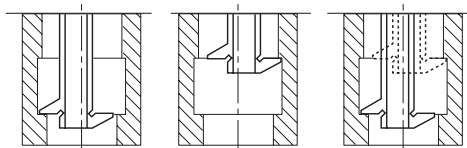

## Technical Data

Order no.	Product type	Measuring range		Resolution	Error limit		Standard
		mm	inch		mm/inch	mm	
4126523	30 EWR-D	0 – 200	0 – 8"	0,01 / .0005"	0,03	.001"	Factory standard
4126524	30 EWR-D	0 – 300	0 – 12"	0,01 / .0005"	0,04	.001"	Factory standard

Order no.	a	b	c
	mm	mm	mm
4126523	281	100	12
4126524	381	150	12

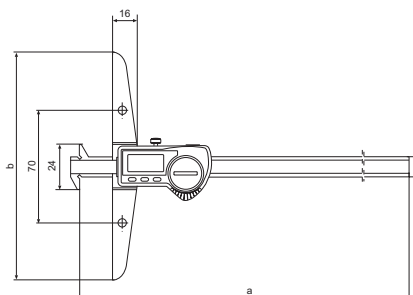

## Functions:

- ON/OFF
- AUTO-ON / OFF
- mm/inch
- LOCK function (key lock)
- RESET (set display to zero)
- PRESET (for entering a numerical value)
- DATA (Data transmission via connection cable)
- High contrast analog display
- Locking screw above
- Lapped guideway
- Measuring surfaces made of steel
- Slide and beam made of hardened stainless steel
- Immediate measurements due to the Reference System
- Raised guideways for the protection of the scale
- Excellent resistance against dust, coolants and lubricants
- Dirt wipers are integrated in the slide
- **Digit height:** 8,5 mm
- **Data interface:** USB, Opto RS232C, Digimatic
- **Energy supply:** Battery life approx. 3 years
- **IP protection category:** IP 67
- **Scope of delivery:** Battery, Instruction manual, Case

## Accessories

Order no.	Product description	Product type
4102357	Data Connection Cable USB (2 m)	16 EXu
4102410	Data Connection Cable RS232C (2 m)	16 EXr
4102520	Battery 3 V, CR 2032	
4102915	Digimatic data cable (2 m)	16 EWd
4126510	Cross Beam Extension (300 mm)	30 EXm
4126511	Cross Beam Extension (200 mm)	30 EXm

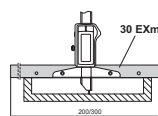

30 EXm



# Digital Depth Gage MarCal 30 EWri-N / 30 EWR-N

## Functions 30 EWri-N:

- ON/OFF
- AUTO-ON / OFF
- mm/inch
- LOCK function (key lock)
- RESET (set display to zero)
- PRESET (for entering a numerical value)
- DATA (Data transmission)
- HOLD (storage of measured values)



## Functions 30 EWR-N:

- ON/OFF
- AUTO-ON / OFF
- mm/inch
- LOCK function (key lock)
- RESET (set display to zero)
- PRESET (for entering a numerical value)
- DATA (Data transmission via connection cable)



- High contrast analog display
- Locking screw above
- Lapped guideway
- Measuring surfaces made of steel
- Slide and beam made of hardened stainless steel
- Immediate measurements due to the Reference System
- Raised guideways for the protection of the scale
- Excellent resistance against dust, coolants and lubricants
- Dirt wipers are integrated in the slide

## Application:

Measuring groove widths and distances between grooves

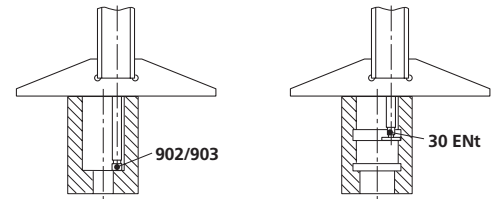

## Features 30 EWri-N:

- **Height of digits:** 11mm
- **Data interface:** Integrated wireless
- **Energy supply:** Battery, life span ca. 3 years
- **IP protection category:** IP 67
- **Scope of delivery:** Battery, Instruction manual, Anvils 30 Ent (1mm), 902 (4mm) and 903 (4mm), Case

## Features 30 EWR-N:

- **Height of digits:** 8,5mm
- **Data interface:** USB, RS232C, Digimatic
- **Energy supply:** Battery, life span ca. 3 years
- **IP protection category:** IP 67
- **Scope of delivery:** Battery, Instruction manual, Anvils 30 Ent (1mm), 902 (4mm) and 903 (4mm), Case

## Technical Data

Order no.	Product type	Measuring range		Resolution	Error limit		Standard
		mm	inch		mm	inch	
4126532	30 EWri-N	0 - 100	0 - 4"	0,01 / .0005"	0,03	.001"	Factory standard
4126513	30 EWR-N	0 - 100	0 - 4"	0,01 / .0005"	0,03	.001"	Factory standard

Order no.	a	b	c
	mm	mm	mm
4126532	268	85	16
4126513	268	85	16

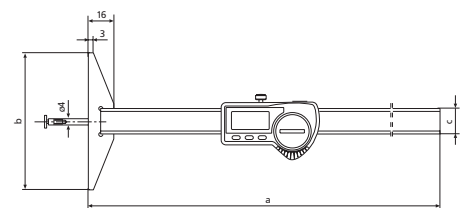

## Accessories

Order no.	For measuring instrument	Product description	Product type
4102220	30 EWri-N	Receiver	i-Stick
4102357	30 EWR-N	Data Connection Cable USB (2 m)	16 EXu
4102410	30 EWR-N	Data Connection Cable RS232C (2 m)	16 EXr
4102520	30 EWri-N, 30 EWR-N	Battery 3 V, CR 2032	
4102915	30 EWR-N	Digimatic data cable (2 m)	16 EWd
4126310	30 EWri-N	Disc Type Anvil (7,5 x 0,5 mm)	30 Ent
4882022	30 EWri-N	Disc Type Anvil (7,5 x 1 mm)	30 Ent



i-Stick

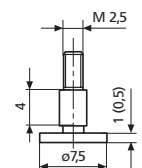

30 Ent



# Depth Gage MarCal 30 N

DIN 862

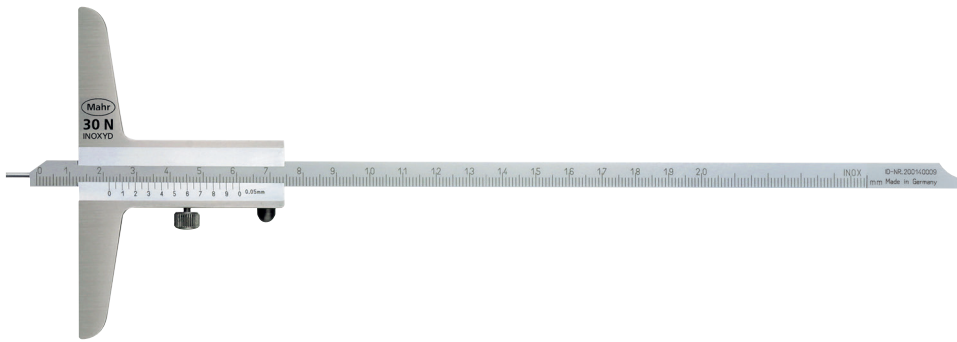

- Vernier and main scale have a satin chrome finish for glare free reading
- Locking screw below
- Hardened measuring pin
- Measuring surfaces made of steel
- Interchangeable beams
- **Scope of delivery:** Case

## Technical Data

Order no.	Product type	Measuring range	Readings	Error limit	Standard
		mm	mm	mm	
4127200	30 N	0 – 80	0,05	0,05	DIN 862
4127300	30 N	0 – 150	0,05	0,05	DIN 862
4127301	30 N	0 – 200	0,05	0,05	DIN 862
4127201	30 N	0 – 300	0,05	0,05	DIN 862
4127202	30 N	0 – 500	0,05	0,07	DIN 862

Order no.	a	b	c	d	g
	mm	mm	mm	mm	mm
4127200	1	50	140	8	
4127300	1,5	100	235	8	3,5
4127301	1,5	100	285	8	3,5
4127201	2	150	390	12	4
4127202	2	150	590	12	4

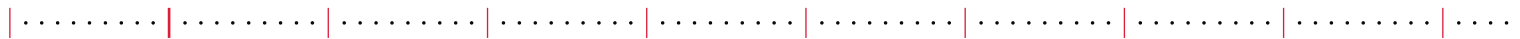
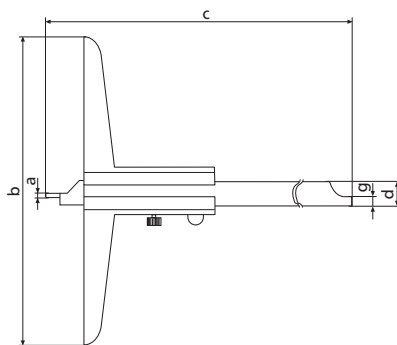



# Depth Gage with hook MarCal 30 NH

DIN 862

- Vernier and main scale have a satin chrome finish for glare free reading
- Locking screw below
- Measuring surfaces made of steel
- Interchangeable beams
- **Scope of delivery:** Case

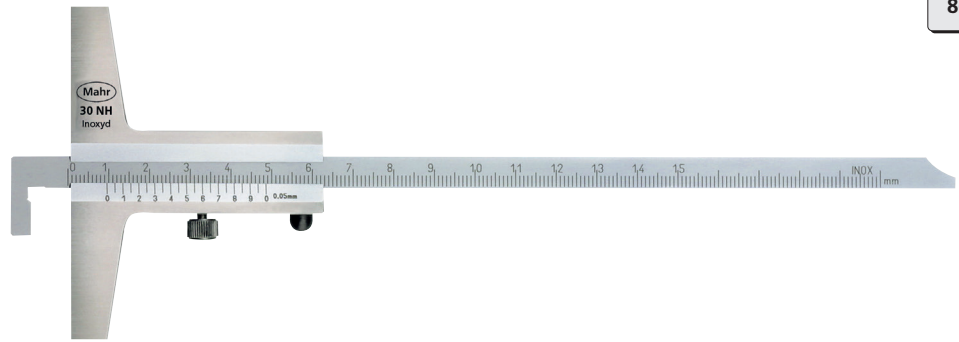

## Technical Data

Order no.	Product type	Measuring range	Readings	Error limit	Standard
		mm	mm	mm	
4127350	30 NH	0 - 150	0,05	0,05	DIN 862
4127351	30 NH	0 - 200	0,05	0,05	DIN 862
4127352	30 NH	0 - 300	0,05	0,05	DIN 862
4127353	30 NH	0 - 500	0,05	0,07	DIN 862

Order no.	b	c	d	e	f	g
	mm	mm	mm	mm	mm	mm
4127350	100	235	8	20	5	3,5
4127351	100	285	8	20	5	3,5
4127352	150	390	12	28	10	4
4127353	150	590	12	28	10	4

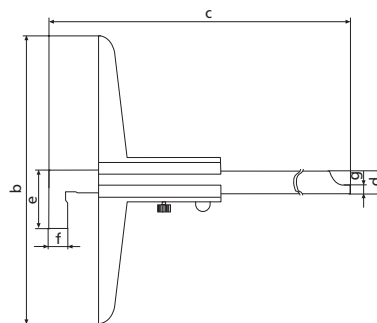



# Depth Gage with twin hook MarCal 30 ND

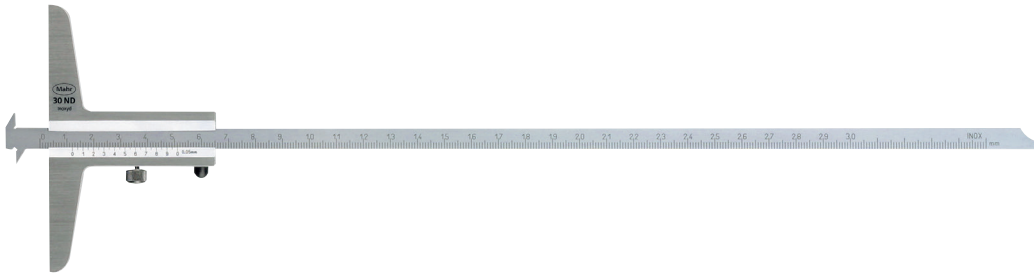

- Vernier and main scale have a satin chrome finish for glare free reading
- Locking screw below
- Measuring surfaces made of steel
- Interchangeable beams
- **Scope of delivery:** Case

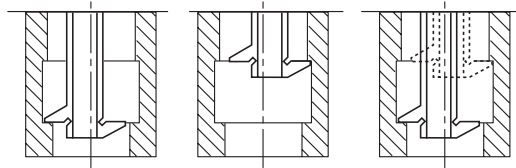

## Technical Data

Order no.	Product type	Measuring range	Readings	Error limit	Standard
		mm	mm	mm	
4127400	30 ND	0 – 200	0,02	0,05	Factory standard
4127401	30 ND	0 – 300	0,02	0,05	Factory standard
4127410	30 ND	0 – 200	0,05	0,05	Factory standard
4127411	30 ND	0 – 300	0,05	0,05	Factory standard

Order no.	b	c	d	g
	mm	mm	mm	mm
4127400	100	285	8	3,5
4127401	100	390	12	4
4127410	100	285	8	3,5
4127411	100	390	12	4

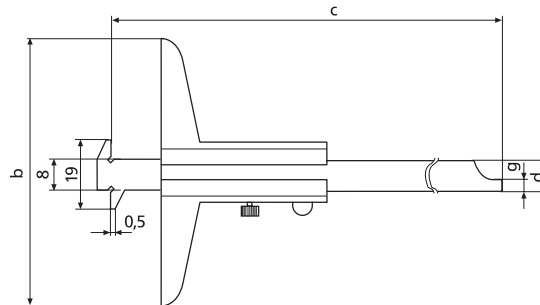





# Digital linear machine scale MarCal 31 EW

## Functions:

- ON/OFF
- RESET (set display to zero)
- mm/inch
- PRESET (for entering a numerical value)
- DATA (Data transmission via connection cable)
- AUTO-ON / OFF

• Control panel and display unit can be rotated for horizontal or vertical installation

• High contrast analog display

• Slide and beam made of hardened stainless steel

• Raised guideways for the protection of the scale

• Dirt wipers are integrated in the slide

• **Software:** MarCom Professional free download:

[www.mahr.com/marcom](http://www.mahr.com/marcom)

(only for Mahr data cables and wireless systems with USB and RS232C interface)

• **Digit height:** 6 mm

• **Data interface:** USB, Opto RS232C

• **Energy supply:** Battery life approx. 3 years

• **IP protection category:** IP 54

• **Scope of delivery:** Drive-type device, Instruction manual, Battery

REFERENCE



## Application:

For measuring travel on a machine (e.g. on an upright drilling machine, milling machine)

## Technical Data

Order no.	Measuring range		Product type	Resolution	Error limit	Error limit	Standard
	mm	inch					
4104100	150	6	31 EW	0,01 / .0005"	0,03	.001"	Factory standard
4104101	200	8	31 EW	0,01 / .0005"	0,03	.001"	Factory standard
4104102	300	12	31 EW	0,01 / .0005"	0,04	.0015"	Factory standard
4104103	600	24	31 EW	0,01 / .0005"	0,05	.002"	Factory standard

Order no.	a	b	c
	mm	mm	mm
4104100	185	282	298
4104101	235	332	348
4104102	335	432	448
4104103	665	762	778

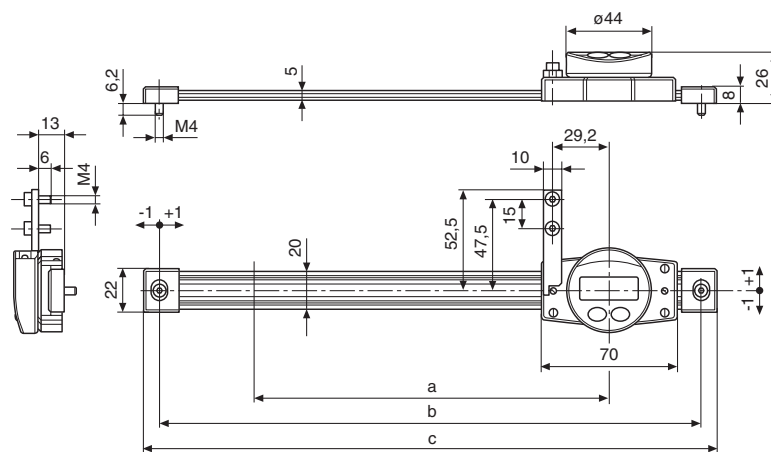

## Accessories

Order no.	Product name	Product type
4102520	Battery 3 V, CR 2032	
4305121	800 EWu Data Connection Cable USB (2 m)	800 EWu
4305122	Data Connection Cable RS232C (2 m)	800 EWr